

# NINJA®

## Foodi® Health Grill & Air Fryer

**AG301UK**

**INSTRUCTIONS**



# THANK YOU

for purchasing the Ninja® Foodi® Health Grill & Air Fryer



## REGISTER YOUR PURCHASE

 [ninjakitchen.co.uk/register-guarantee](http://ninjakitchen.co.uk/register-guarantee)

 Scan QR code using mobile device

## RECORD THIS INFORMATION

Model Number: \_\_\_\_\_

Serial Number: \_\_\_\_\_

Date of Purchase: \_\_\_\_\_  
(Keep receipt)

Store of Purchase: \_\_\_\_\_

## TECHNICAL SPECIFICATIONS

Voltage: 220-240~ 50-60Hz

Watts: 1760W

**TIP:** You can find the model and serial numbers on the QR code label located on the back of the unit by the power cord.

# CONTENTS

<b>Important Safeguards</b> .....	<b>4</b>
<b>Parts</b> .....	<b>6</b>
<b>Getting to Know Your Grill</b> .....	<b>7</b>
Function Buttons .....	7
Operating Buttons .....	7
<b>Before First Use</b> .....	<b>7</b>
<b>Using Your Grill</b> .....	<b>8</b>
Splatter Guard .....	8
Grill Control Technology .....	8
Cooking Functions .....	9
Grill .....	9
Air Fry .....	10
Roast .....	11
Bake .....	12
Dehydrate .....	13
<b>Cleaning Your Grill</b> .....	<b>13</b>
<b>Troubleshooting Guide</b> .....	<b>14</b>
<b>Product Registration</b> .....	<b>15</b>

# IMPORTANT SAFEGUARDS

HOUSEHOLD USE ONLY • READ ALL INSTRUCTIONS BEFORE USE

Read all instructions before using your Ninja® Foodi® Grill.

When using electrical appliances, basic safety precautions should always be followed, including the following:

## ⚠ WARNING

- 1 To eliminate a choking hazard for young children, discard all packaging materials immediately upon unpacking.
- 2 This appliance can be used by persons with reduced physical, sensory or mental capabilities or lack of experience and knowledge if they have been given supervision or instruction concerning use of the appliance in a safe way and understand the hazards involved.
- 3 Keep the appliance and its cord out of reach of children. **DO NOT** allow the appliance to be used by children. Close supervision is necessary when used near children.
- 4 This appliance is for household use only. **DO NOT** use this appliance for anything other than its intended use. **DO NOT** use in moving vehicles or boats. **DO NOT** use outdoors. Misuse may cause injury.
- 5 Ensure the surface is level, clean and dry. **DO NOT** place the appliance near the edge of a worktop during operation.
- 6 **ALWAYS** ensure the appliance is properly assembled before use.
- 7 When using this appliance, provide at least 15.25 cm (6 inches) of space above and on all sides for air circulation.
- 8 **DO NOT** use an extension cord. A short power-supply cord is used to reduce the risk of children grabbing the cord or becoming entangled and to reduce the risk of people tripping over a longer cord.
- 9 To protect against electrical shock **DO NOT** immerse cord, plugs, or main unit housing in water or other liquid.
- 10 **DO NOT** use the appliance if there is damage to the power cord or plug. Regularly inspect the appliance and power cord. If the appliance malfunctions or has been damaged in any way, immediately stop use and call Customer Service.
- 11 **NEVER** use socket below worktop surface level.
- 12 **NEVER** connect this appliance to an external timer switch or separate remote-control system.
- 13 **DO NOT** place appliance and let cord hang over edges of tables, counters or touch hot surfaces including on or near a hot gas or electric burner, or in a heated oven.
- 14 Only use recommended accessories included with this appliance or authorized by SharkNinja. The use of accessories or attachments not recommended by SharkNinja may cause a risk of fire or injury.
- 15 Before placing any accessory into the cooker, ensure they are clean and dry.
- 16 **DO NOT** use the appliance without the removable cooking pot and splatter guard installed.
- 17 **ALWAYS** ensure lid is fully closed before operating.
- 18 **DO NOT** move the appliance when in use.
- 19 **DO NOT** cover the air intake vent or air socket vent while unit is operating. Doing so will prevent even cooking and may damage the unit or cause it to overheat.

- 20 **DO NOT** touch hot surfaces. Appliance surfaces are hot during and after operation. To prevent burns or personal injury, **ALWAYS** use protective hot pads or insulated oven gloves and use available handles and knobs.
- 21 **DO NOT** touch accessories during or immediately after cooking. The grill plate and basket becomes extremely hot during the cooking process. Avoid physical contact while removing the accessory from the appliance. To prevent burns or personal injury **ALWAYS** use care when interfacing with product. Recommend use of long handed utensil and protective hot pads or insulated oven gloves.
- 22 **DO NOT** use this appliance for deep-frying.
- 23 To prevent possible illness, **ALWAYS** use a thermometer to check that your food is cooked to the recommended temperatures.
- 24 Should a grease fire occur or the unit emits black smoke, unplug immediately. Wait for smoking to stop before removing any cooking accessories.
- 25 Please refer to the Cleaning & Maintenance section for regular maintenance of the appliance.
- 26 To disconnect, turn any control to “off”, then unplug from socket when not in use and before cleaning.
- 27 Allow to cool before cleaning, disassembly, putting in or taking off parts and for storage.
- 28 **DO NOT** clean with metal scouring pads. Pieces can break off the pad and touch electrical parts, creating a risk of electric shock.
- 29 Cleaning and user maintenance shall not be made by children.



Indicates to read and review instructions to understand operation and use of product.



Indicates the presence of a hazard that can cause personal injury, death or substantial property damage if the warning included with this symbol is ignored.



Take care to avoid contact with hot surface. Always use hand protection to avoid burns.



For indoor and household use only.

## SAVE THESE INSTRUCTIONS

## PARTS

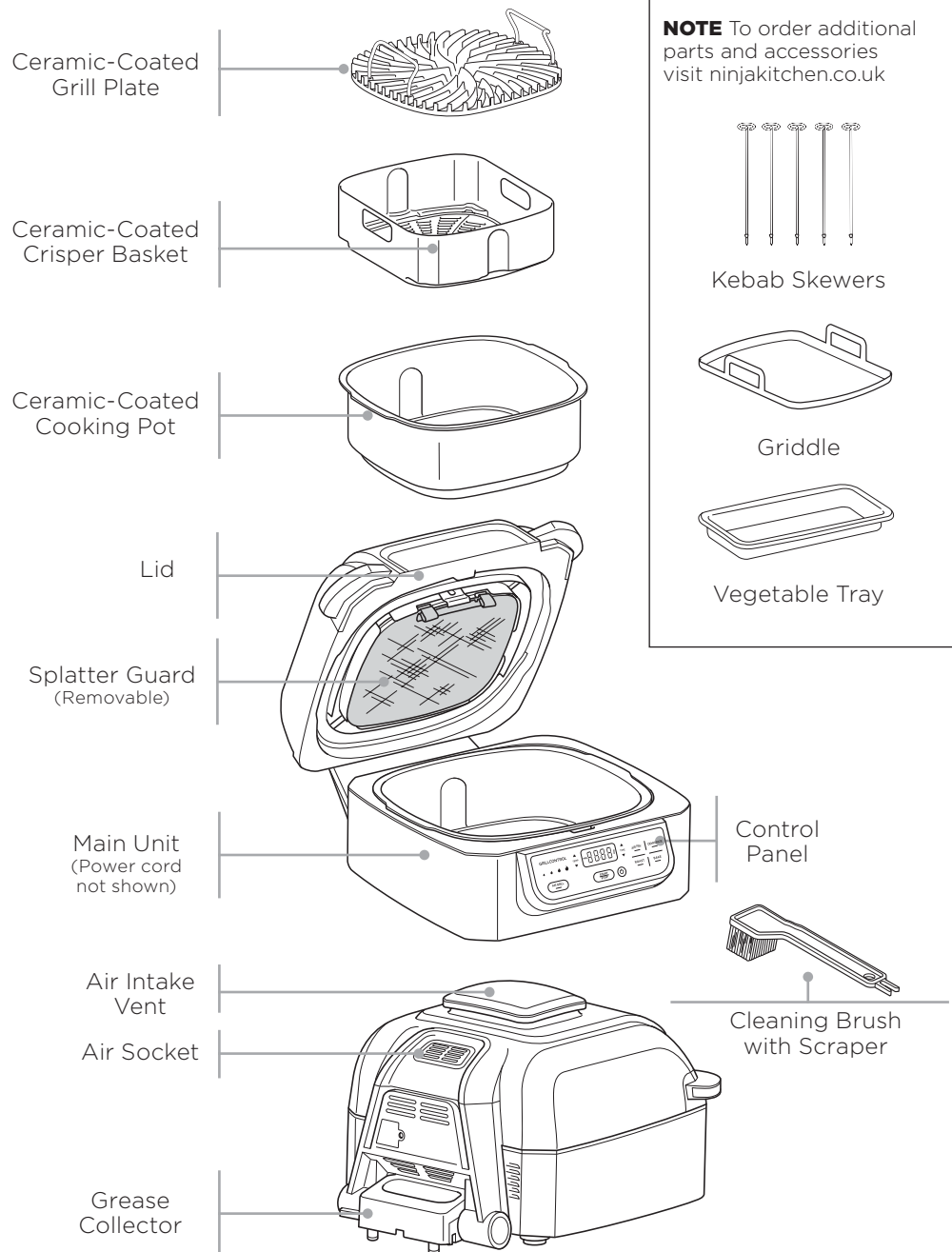

## GETTING TO KNOW YOUR GRILL

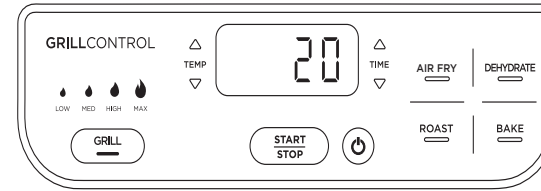

The control panel display shows time in an HH:MM format. The display to the left reads 20 minutes.

### FUNCTION BUTTONS

**GRILL** Sizzle and sear foods, with chargrilled lines and all round even cooking.

**AIR FRY** For crispiness and crunch with little to no oil.

**ROAST** Tenderise meats, roast vegetables and more.

**BAKE** Use to bake cakes, treats, desserts and more.

**DEHYDRATE** Dehydrate meats, fruits and vegetables for healthy homemade snacks.

### OPERATING BUTTONS

**POWER button** Once the unit is plugged in, press the power button to turn on the unit. Pressing it during cooking stops the current cooking function and turns off the unit.

**TEMP arrows** Use the up and down TEMP arrows to adjust the cooking temperature in any function. When using the Grill function, toggle the GRILL button or use the up and down arrows to adjust cooking temperature.

**TIME arrows** Use the up and down TIME arrows to adjust the cook time in any function.

**NOTE:** To adjust temperature or time during cooking, press the up and down arrows. The unit will then resume at those settings.

**START/STOP button** After selecting temperature and time, press the START/STOP button to begin cooking.

### STANDBY MODE

The unit will power off if cooking is not in process and there has been no interaction with the control panel for 10 minutes.

## BEFORE FIRST USE

- 1 Remove all packaging material, promotional labels and tape from the unit.
- 2 Remove all accessories from the package and read this manual carefully. Please pay particular attention to operational instructions, warnings and important safeguards to avoid any injury or property damage.
- 3 Wash the grill plate, splatter guard, crisper basket, cleaning brush and cooking pot in warm, soapy water, then rinse and dry thoroughly. The grill plate, splatter guard, crisper basket, cleaning brush and cooking pot are also dishwasher safe. **NEVER** clean the main unit in the dishwasher.

# USING YOUR GRILL

## SPLATTER GUARD

Located on the underside of the lid, the splatter guard keeps the heating element clean and prevents smoking. The splatter guard is removable for cleaning, but we recommend keeping it in place when cooking.

### Removing the splatter guard

Remove the splatter guard for cleaning after every use. First allow the splatter guard to cool completely, then remove it by using your thumb to release the front clip by pushing the front clip upward and using your other hand to pull one of the tabs toward you. This will release the splatter guard, allowing you to pull it out of the slot along the back of the lid.

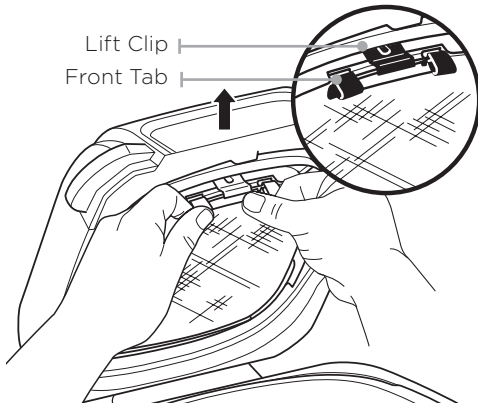

### Installing the splatter guard

To install, gently push the splatter guard into the back of the lid. Insert the back tab on guard with the slot on the back of the lid. Then push the splatter guard upward until it clicks into the clip on the front of the lid.

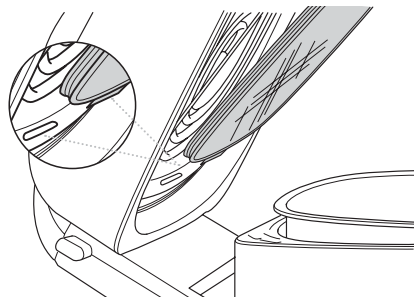

## GRILL CONTROL TECHNOLOGY

Our technology allows you to control the temperature of the grill plate for precise cooking and keep smoke out of the kitchen.

When using the Grill function, you will need to select the grill plate temperature setting. Below are recommended temperature levels for common ingredients.

LOW	MEDIUM	HIGH	MAX
<ul style="list-style-type: none"> <li>• Bacon</li> <li>• Sausages</li> <li>• Stuffed peppers</li> <li>• When using thick barbecue sauces</li> <li>• Calzones</li> </ul>	<ul style="list-style-type: none"> <li>• Frozen Meats</li> <li>• Marinated/coated meat</li> </ul>	<ul style="list-style-type: none"> <li>• Steaks</li> <li>• Chicken</li> <li>• Burgers</li> <li>• Hot dogs</li> </ul>	<ul style="list-style-type: none"> <li>• Veggies</li> <li>• Fruit</li> <li>• Pizzas</li> <li>• Fresh/Frozen Seafood</li> <li>• Kebabs</li> </ul>

**NOTE:** The unit could create smoke during the cooking process. For less smoke, we recommend using vegetable oil, coconut, avocado or grapeseed instead of olive oil.

**NOTE:** The unit may produce smoke when cooking meats on a hotter setting than what is recommended. For more cooking charts, refer to your Inspiration Guide or visit [ninjakitchen.co.uk](http://ninjakitchen.co.uk).

### Batch grilling

When grilling more than two consecutive batches of food, it is recommended that you empty the fat/oil from the removable cooking pot. This will help prevent grease from burning and causing smoke.

We also recommend allowing the grill plate to heat back up for at least 3-5 minutes between batches to ensure consistent grill marks and cooking.

### Switching to Grill after using another function

If the unit is already warm from using a different function, and the grill plate is at room temperature when you place it in the unit, "Add Food" may appear on the screen immediately. We recommend allowing the grill to heat up for at least 6 minutes before

placing ingredients on it. As the unit continues to run and the grill plate heats up, "Add Food" will remain on the screen until you open the lid and place ingredients on the grill plate.

## COOKING FUNCTIONS

Ensure the unit is plugged in before turning it on. Press the power button.

### Grill

- Place the cooking pot in the unit with the indent on the pot aligned with the rear bump on the main unit. Then place the grill plate in the pot with the handles facing up. Ensure the splatter guard is in place and close the lid.

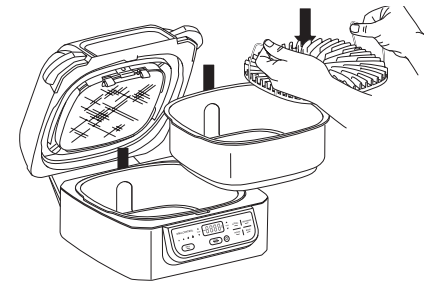

- Press the GRILL button. The default temperature level will illuminate on the left side of the control panel and the corresponding air temperature will appear on the display screen. Press the Grill button or the up and down TEMP arrows to adjust the temperature setting.



- Press the up and down TIME arrows to set the cooking time in one-minute increments, up to 30 minutes.

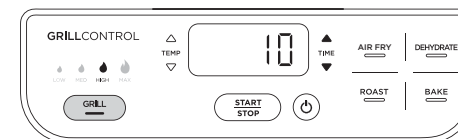

- Press the START/STOP button to begin preheating. PRE will appear on the display screen and the progress bar will begin. It can take about 8 minutes to preheat, depending on the selected temperature setting.

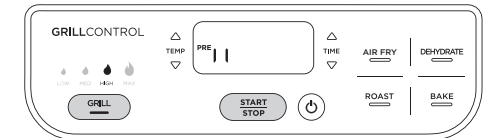

- When preheating is complete, the unit will beep and Add Food will flash across on the display screen.



- Open the lid and place ingredients on the grill plate. Once the lid is closed, cooking will begin and the timer will start counting down.

**NOTE:** During cooking, you can open the lid to check on or flip your food. The timer will pause when the lid is opened and then automatically resume after it is closed.

- When cook time is complete, the unit will beep and END will appear on the display screen. Keep the lid open after removing your food so the unit will cool down more quickly. The stainless steel wrap on the exterior of the unit will be hot after cooking. If you need to cook your food longer, simply press the TIME up arrow to add more time, then press the START/STOP button.

**NOTE:** If batch cooking, empty the oil from the removable cooking pot after every 2 batches. This will help prevent grease from burning and causing smoke.

## USING YOUR GRILL - CONT.

### Air Fry

- Place cooking pot in the unit with the indent on the pot aligned with the bump on the main unit. Place the crisper basket in the pot, then close the lid.

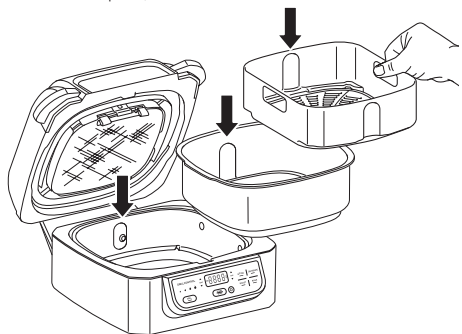

- Press the Air Fry button. The default temperature setting will display. Use the up and down TEMP arrows to adjust the temperature.



- Use the up and down TIME arrows to set the cook time in 1-minute increments up to 1 hour.



- Press the START/STOP button to begin preheating. PRE will appear on the display screen and the progress bar will begin. It can take up to 3 minutes to preheat, depending on the selected temperature setting.

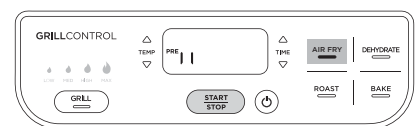

**NOTE:** While preheating is strongly recommended for best results, you can skip it by pressing the Air Fry button again. Add Food will flash across the screen. Open the lid and place ingredients in the crisper basket. Once the lid is closed cooking will begin and the timer will start counting down. Skip to step 7 for further instructions.

- When preheating is complete, the unit will beep and Add Food will flash across on the display screen.



- Open the lid and place ingredients in the crisper basket. Once the lid is closed, cooking will begin and the timer will start counting down.

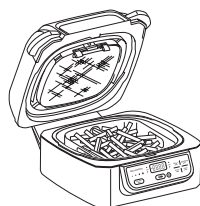

- For best results, we recommend shaking ingredients frequently. When you open the lid, the unit will pause. Use silicone tipped tongs when tossing your food or oven gloves to shake the basket. When done, replace the basket and close the lid. Cooking will automatically resume after lid is closed.



- When cook time is complete, the unit will beep and END will appear on the display screen. Keep the lid open after removing your food so the unit will cool down more quickly. The stainless steel wrap on the exterior of the unit will be hot after cooking. If you need to cook your food longer, simply press the TIME up arrow to add more time, then press the START/STOP button.

### Roast

- Place cooking pot in the unit with the indent on the pot aligned with the bump on the main unit, then close the lid.

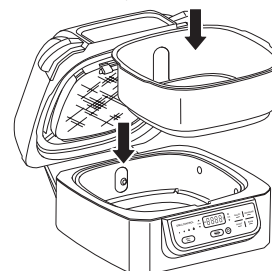

- Press the ROAST button. The default temperature setting will display. Use the up and down TEMP arrows to adjust the temperature.

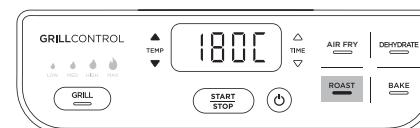

**NOTE:** To convert conventional oven recipes, reduce the temperature by 10°C. Check food frequently to avoid overcooking.

- Use the up and down TIME arrows to set the cook time, in 15-minute increments, up to 4 hours.

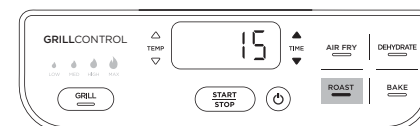

- Press the START/STOP button to begin preheating. PRE will appear on the display screen and the progress bar will begin. It can take up to 3 minutes to preheat, depending on the selected temperature setting.

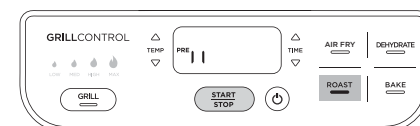

**NOTE:** While preheating is strongly recommended for best results, you can skip it by pressing the ROAST button again. Add Food will flash across the screen. Open the lid and place ingredients in the crisper basket. Once the lid is closed cooking will begin and the timer will start counting down.

- When preheating is complete, the unit will beep and Add Food will flash across on the display screen.



- Open the lid and place ingredients in the pot. Once the lid is closed, cooking will begin and the timer will start counting down.

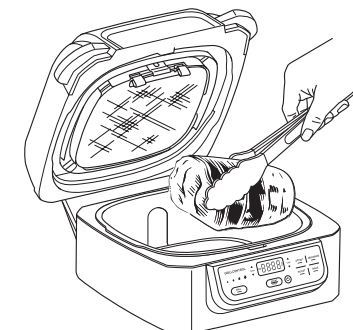

**NOTE:** During cooking, you can open the lid to check on your food. The timer will pause when the lid is opened and then automatically resume after it is closed.

- When cook time is complete, the unit will beep and END will appear on the display screen. Keep the lid open after removing your food so the unit will cool down more quickly. The stainless steel wrap on the exterior of the unit will be hot after cooking. If you need to cook your food longer, simply press the TIME up arrow to add more time, then press the START/STOP button.

## USING YOUR GRILL - CONT.

### Bake

- 1 Place cooking pot in the unit so the indent on the pot aligned with the bump on the main unit, then close the lid.

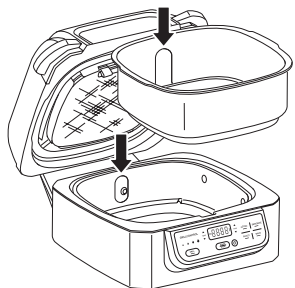

- 2 Press the BAKE button. The default temperature setting will display. Use the up and down TEMP arrows to adjust the temperature.

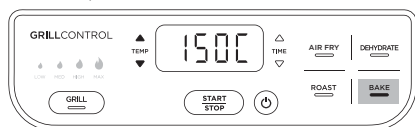

**NOTE:** To convert conventional oven recipes, reduce the temperature by 10°C. Check food frequently to avoid overcooking.

- 3 Use the up and down TIME arrows to set the cook time, in 15-minute increments, up to 2 hours.

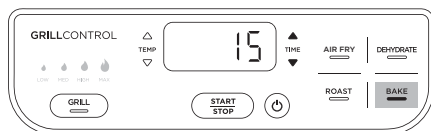

- 4 Press the START/STOP button to begin preheating. PRE will appear on the display screen and the progress bar will begin. It can take up to 3 minutes to preheat, depending on the selected temperature setting.

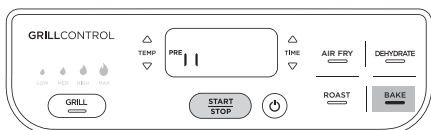

**NOTE:** While preheating is strongly recommended for best results, you can skip it by pressing the BAKE button again. Add Food will flash across the screen. Open the lid and place ingredients in the crisper basket. Once the lid is closed cooking will begin and the timer will start counting down.

- 5 When preheating is complete, the unit will beep and Add Food will flash across on the display screen.



- 6 Open the lid and add ingredients to the pot or set your bake pan directly in the bottom of the pot and close the lid to start cooking. Once the lid is closed, cooking will begin and the timer will start counting down.

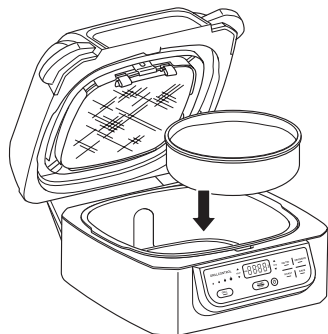

**NOTE:** During cooking, you can open the lid to check on your food. The timer will pause when the lid is opened and then automatically resume after it is closed.

- 7 When cook time is complete, the unit will beep and END will appear on the display screen. Keep the lid open after removing your food so the unit will cool down more quickly. The stainless steel wrap on the exterior of the unit will be hot after cooking. If you need to cook your food longer, simply press the TIME up arrow to add more time, then press the START/STOP button.

### Dehydrate

- 1 Place cooking pot in the unit with the indent on the pot aligned with the bump on the main unit, then add a single layer of ingredients to the bottom of the pot. Place the crisper basket in the pot and add a layer of ingredients to the bottom of the basket. Close the lid.

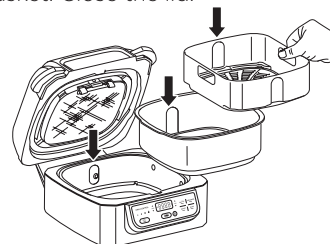

- 2 Press the DEHYDRATE button. The default temperature setting will display. Use the up and down TEMP arrows to set your desired temperature.

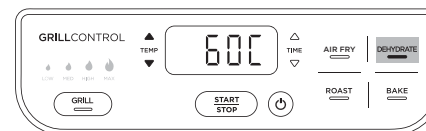

- 3 Use the up and down TIME arrows to set the dehydration time, in 15-minute increments, up to 12 hours.

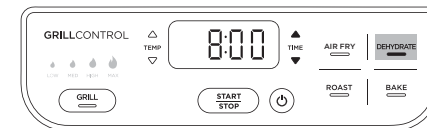

- 4 Press the START/STOP button to begin. The unit does not need to preheat.

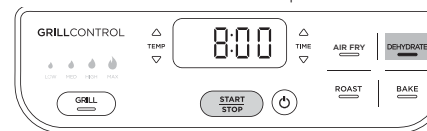

**NOTE:** During dehydration, you can open the lid to check on your food. The timer will pause when the lid is opened and then automatically resume after it is closed.

- 5 When dehydration time is complete, the unit will beep and END will appear on the display screen. Remove your food and close the lid.

## CLEANING YOUR GRILL

The unit should be cleaned thoroughly after every use. Always let the appliance cool before cleaning.

- Unplug the unit from the wall socket before cleaning. Keep the lid open after removing your food so the unit will cool down more quickly.
- To clean the main unit and control panel, wipe them with a damp cloth.
- The cooking pot, grill plate, crisper basket, splatter guard, cleaning brush and any other additional Ninja grill accessories are dishwasher safe.

**NOTE: NEVER** use abrasive tools or cleaners. **NEVER** immerse the main unit in water or any other liquid.

- If hand-washing, use the cleaning brush to help wash the parts. Use the opposite end of the cleaning brush as a scraper to assist with releasing baked-on foods. Air-dry or towel-dry all parts after hand-washing.
- If food residue or grease are stuck on the grill plate, splatter guard, or any other removable part, place them in a sink or stack them in the pot and fill with warm, soapy water and allow to soak for a couple hours or overnight. After soaking, use the cleaning brush to clean each part.
- Over time, the splatter guard front tabs and frame may accumulate grease. Soaking the splatter guard overnight will help soften the baked-on grease. After soaking, use the cleaning brush to remove the grease from the stainless steel frame and front tabs.

## TROUBLESHOOTING GUIDE

- **“Add Food” appears on the control panel display.**  
The unit has completed its Grill preheating and it is now time to add your ingredients.
- **“Shut Lid” appears on the control panel display.**  
The lid is open and needs to be closed for the selected function to start.
- **“Add Pot” appears on the control panel display.**  
The pot is not installed in the unit.
- **“E” appears on the control panel display.**  
The unit is not functioning properly. Please contact Customer Service at 0800 862 0453.
- **Why do blinking lights appear after I press the START/STOP button?**  
This is a progress bar indicating how far along you are in the preheating cycle.
- **Why does the preheat progress bar not start from the beginning?**  
When the unit is warm from previously being used, it will not require the full preheating time.
- **Should I add my ingredients before or after preheating?**  
Let the unit preheat before adding ingredients.
- **Why is my unit emitting smoke?**  
When using the Grill function, always select the recommended temperature setting. Recommended settings can be found in the Quick Start Guide/ Inspiration Guide. Make sure the splatter guard is installed.
- **How do I pause the unit so I can check my food?**  
When the lid is opened during a cooking function, the unit will automatically pause.
- **My food is burned.**  
Do not add food until preheating is complete. For best results, check progress throughout cooking and remove food when desired level of brownness has been achieved. Remove food immediately after the cook time is complete to avoid overcooking.
- **My food didn’t cook when Air Frying.**  
For consistent browning, make sure ingredients are arranged in an even layer on the bottom of the crisper basket with no overlapping. Shake loose ingredients during cooking for consistent crispiness.
- **Why is my food blowing around when Air Frying?**  
Occasionally, the fan will blow lightweight foods around. To prevent this, secure loose food (like the top slice of bread on a sandwich) with cocktail sticks.
- **Can I Air Fry fresh battered ingredients?**  
Yes, but use the proper breading technique. It is important to coat foods first with flour, then with egg and then with bread crumbs. Be sure to press the bread crumbs onto the food so they stick in place. Loose breading may be blown off by the unit’s powerful fan.
- **The control panel display is no longer illuminated.**  
The unit is off. Press the power button to turn it back on.
- **Can I cancel or override preheating?**  
Preheating is highly recommended for best results. Skip preheating by selecting the function again after you press the START/STOP button. However, you cannot override preheating when using the Grill function.
- **How can I deep clean the splatter guard?**  
The splatter guard should be cleaned after each use and is dishwasher safe. Over time, the splatter guard front tabs and frame may accumulate grease buildup. Soaking the splatter guard overnight will help soften the baked-on grease. After soaking, use the cleaning brush to remove the grease from the stainless steel frame and front tabs.

## NINJA PRODUCT REGISTRATION

When you register we’ll have your details to hand in the unlikely event of a product safety notification. If you further agree to receive communications from us, you can also receive tips and advice on how to get the best out of your Ninja product and hear the latest news about new Ninja products. By registering, you acknowledge you have read and understood the instructions for use and warning set forth in the accompanying instructions.

Visit [ninjakitchen.co.uk/registerguarantee](http://ninjakitchen.co.uk/registerguarantee) to register.



VISIT US ONLINE AT:

ninjakitchen.co.uk

Or follow us on any of our social media pages:



**NOTE:** Save these instructions. Keep for future reference.



This marking indicates this product should not be disposed of with other household waste. To prevent possible harm to the environment or human health from uncontrolled waste disposal, recycle it responsibly to promote the sustainable reuse of material sources. To return your used device, please use the return and collection systems or contact the retailer where this product was purchased. They can take this product for environmentally safe recycling.

**SharkNinja Europe Limited**  
**3150 Century Way**  
**Thorpe Park, Leeds**  
**LS15 8ZB, UK**  
**ninjakitchen.co.uk**

**SharkNinja Germany GmbH,**  
**c/o Regus Management GmbH**  
**Excellent Business Center 10**  
**+11/Stock Westhafenplatz 1,**  
**60327 Frankfurt am Main,**  
**Germany**  
**ninjakitchen.eu**

Illustrations may differ from actual product. We are constantly striving to improve our products, therefore the specifications contained herein are subject to change without notice.

FOODI and NINJA are registered trademarks of SharkNinja Operating LLC.

© 2021 SharkNinja Operating LLC  
AG301UK\_Series\_IB\_MP\_210719\_Mv1  
PRINTED IN CHINA

