

# NINJA®

## Foodi® Multi-Cooker

### OP300UK

### INSTRUCTIONS



ninjakitchen.co.uk

# THANK YOU

for purchasing the Ninja® Foodi®



## REGISTER YOUR PURCHASE

 [ninjakitchen.co.uk](http://ninjakitchen.co.uk)

 Scan QR code using mobile device

## RECORD THIS INFORMATION

Model Number: \_\_\_\_\_

Serial Number: \_\_\_\_\_

Date of Purchase: \_\_\_\_\_  
(Keep receipt)

Store of Purchase: \_\_\_\_\_

## THIS BOOK COVERS MODEL NUMBER:

OP300UK

## TECHNICAL SPECIFICATIONS

Voltage: 230V~, 50Hz

Power: 1460W

Volume: 6L

Fluid Group: 2

PS: 40 kPa

**TIP:** You can find the model and serial numbers on the QR code label located on the back of the unit by the power cord.

# CONTENTS

<b>Important Safeguards</b> .....	<b>2</b>
<b>Parts &amp; Accessories</b> .....	<b>6</b>
<b>Using the Control Panel</b> .....	<b>8</b>
Function Buttons .....	8
Operating Buttons .....	8
<b>Before First Use</b> .....	<b>9</b>
Installing the Condensation Collector .....	9
Removing & Reinstalling the Anti-Clog Cap .....	9
<b>Using Your Ninja® Foodi® Tendercrisp® Multi-Cooker</b> .....	<b>10</b>
Why Two Lids .....	10
Using the Crisping Lid .....	10
Using the Cooking Functions with the Crisping Lid .....	10
Air Crisp .....	10
Bake/Roast .....	11
Grill .....	12
Familiarising Yourself With Pressure Cooking .....	13
Natural Pressure Release vs. Quick Pressure Release .....	14
Pressurising .....	14
Installing & Removing the Pressure Lid .....	15
Using the Cooking Functions with the Pressure Lid .....	16
Pressure Cook .....	16
Steam .....	17
Slow Cook .....	18
Sear/Sauté .....	18
<b>Cleaning &amp; Maintenance</b> .....	<b>19</b>
Cleaning: Dishwasher & Hand-Washing .....	19
Removing & Reinstalling the Silicone Ring .....	19
<b>Accessories for Purchase</b> .....	<b>20</b>
<b>Troubleshooting Guide</b> .....	<b>21</b>
<b>Helpful Tips</b> .....	<b>23</b>
<b>Replacement Parts</b> .....	<b>23</b>
<b>Product Registration</b> .....	<b>23</b>

# IMPORTANT SAFEGUARDS

HOUSEHOLD USE ONLY • READ ALL INSTRUCTIONS BEFORE USE

Read all instructions before using your Ninja® Foodi®.

When using electrical appliances, basic safety precautions should always be followed, including the following:

## ⚠ WARNING

- 1 To eliminate a choking hazard for young children, remove and discard the protective cover fitted on the power plug of this appliance.
- 2 This appliance can be used by persons with reduced physical, sensory or mental capabilities or lack of experience and knowledge if they have been given supervision or instruction concerning use of the appliance in a safe way and understand the hazards involved.
- 3 **DO NOT** place appliance on hot surfaces or near a hot gas or any electric burner or glass stovetop, on or in a heated oven or stovetop.
- 4 When using this appliance, provide at least 6 inches (15cm) of space above and on all sides for air circulation.
- 5 **ALWAYS** tilt the lid so that it is between your body and the inner pot so that you can be shielded from steam and hot liquids.
- 6 **DO NOT** attempt to open the lid during or after pressure cooking until all internal pressure has been released through the pressure release valve and the unit has cooled slightly. **DO NOT** tamper with, disassemble, or otherwise remove the float valve or pressure release assembly.
- 7 If the lid will not turn to unlock, this indicates the appliance is still under pressure. Any pressure remaining can be hazardous. Let unit naturally release pressure or turn the Pressure Release Valve slowly to the VENT position to release steam. Take care to avoid contact with the releasing steam to avoid burns or injury. When the steam is completely released, the float valve will be in the lower position allowing the lid to be removed.
- 8 Keep the appliance and its cord out of reach of children. **DO NOT** allow the appliance to be used by children. Close supervision is necessary when using near children.
- 9 Children should not play with the appliance.
- 10 **NEVER** use socket below counter.
- 11 **NEVER** connect this appliance to an external timer switch or separate remote-control system.
- 12 **DO NOT** use an extension cord. A short power-supply cord is used to reduce the risk of children less than 8 years grabbing the cord or becoming entangled and to reduce the risk of people tripping over a longer cord.
- 13 To protect against electrical shock **DO NOT** immerse cord, plugs, or main unit housing in water or other liquid. Cook only in the pot provided or in a container recommended by SharkNinja placed in the provided pot.

- 14 Regularly inspect the appliance and power cord. **DO NOT** use the appliance if there is damage to the power cord or plug. If the appliance malfunctions or has been damaged in any way, immediately stop use and call Customer Service.
- 15 **ALWAYS** ensure the appliance is properly assembled before use.
- 16 Before use, **ALWAYS** check pressure release valve and float valve for clogging or obstruction, and clean them if necessary. Check to make sure the float valve on the pressure lid moves freely. Foods such as apple sauce, cranberries, pearl barley, oatmeal or other cereals, split peas, noodles, macaroni, rhubarb, or spaghetti can foam, froth, and splutter when pressure cooked, clogging the pressure release valve. These and similar expanding foods (such as dried vegetables, beans, grains, and rice) should not be cooked in a pressure cooker, except when following a Ninja® Foodi® recipe.
- 17 **DO NOT** cover the air intake vent or air socket vent while crisping lid is closed. Doing so will prevent even cooking and may damage the unit or cause it to overheat.
- 18 To prevent risk of explosion and injury, use only SharkNinja Silicone Rings. Make certain Silicone Ring is installed and lid is properly closed before operating. **DO NOT** use if torn or damaged. Replace before using.
- 19 Before placing removable cooking pot into the cooker base, ensure pot and cooker base are clean and dry by wiping with a soft cloth.
- 20 This appliance is for household use only. **DO NOT** use this appliance for anything other than its intended use. **DO NOT** use in moving vehicles or boats. **DO NOT** use outdoors. Misuse may cause injury.
- 21 Intended for worktop use only. Ensure the surface is level, clean and dry. **DO NOT** move the appliance when in use.
- 22 **DO NOT** use accessory attachments not recommended or sold by SharkNinja. **DO NOT** place accessories in a microwave, toaster oven, convection oven, or conventional oven or on a ceramic cooktop, electric coil, gas burner range, or outdoor grill. The use of accessory attachments not recommended by SharkNinja may cause fire, electric shock, or injuries.
- 23 **ALWAYS** follow the maximum and minimum quantities of liquid as stated in instructions and recipes.
- 24 **NEVER** use SLOW COOK setting without food and liquids in the removable cooking pot.
- 25 **DO NOT** use the appliance without the removable cooking pot installed.
- 26 **DO NOT** use this appliance for deep frying.
- 27 **DO NOT** cover the pressure valves.
- 28 **DO NOT** sauté or fry with oil while pressure cooking.
- 29 Prevent food contact with heating elements. **DO NOT** overfill or exceed the MAX fill level when cooking. Overfilling may cause personal injury or property damage or affect the safe use of the appliance.

## SAVE THESE INSTRUCTIONS

# IMPORTANT SAFEGUARDS

HOUSEHOLD USE ONLY • READ ALL INSTRUCTIONS BEFORE USE

- 30** When pressure cooking foods that expand (such as dried vegetables, beans, grains, rice, etc.). **DO NOT** fill pot more than halfway, or as otherwise instructed in a Ninja® Foodi® recipe.
- 31** **DO NOT** use this unit to cook instant rice.
- 32** To prevent food contact with the heating elements, **DO NOT** overfill the Cook & Crisp Basket.
- 33** Use extreme caution when closing the crisping lid, taking care that nothing is caught in or pinched by the hinge.
- 34** Socket voltages can vary, affecting the performance of your product. To prevent possible illness, use a thermometer to check that your food is cooked to the temperatures recommended.
- 35** **DO NOT** place the appliance near the edge of a worktop during operation.
- 36** To avoid possible steam damage, place the unit away from walls and cabinets during use.
- 37** Should the unit emit black smoke, unplug immediately and wait for smoking to stop before removing the cooking pot and Cook & Crisp Basket.
- 38** **DO NOT** touch hot surfaces. Appliance surfaces are hot during and after operation. To prevent burns or personal injury, **ALWAYS** use protective hot pads or insulated oven mitts and use available handles and knobs.
- 39** Extreme caution must be used when the cooker contains hot oil, hot food, or hot liquids, or if the cooker is under pressure. Improper use, including moving the cooker, may result in personal injury. When using this appliance to pressure cook, ensure the lid is properly assembled and locked into position before use.
- 40** Caution should be used when searing meats and sautéing in hot oil. Keep hands and face away from the removable cooking pot, especially when adding new ingredients, as hot oil may splatter.
- 41** When unit is in operation, hot steam is released through the air socket vent. Place unit so vent is not directed toward the power cord, sockets, or other appliances. Keep your hands and face at a safe distance from vent.
- 42** When using SLOW COOK or SEAR/SAUTÉ settings, **ALWAYS** keep the pressure lid closed and the pressure release valve in the VENT position. If the lid is closed and the pressure release valve is in the SEAL position, an audible alarm will sound. "VENT" error code will appear on LED display to signal the need to turn the pressure release valve to the VENT position.
- 43** When using the PRESSURE COOK setting, **ALWAYS** keep the pressure lid locked and the pressure release valve turned anticlockwise to the SEAL position.
- 44** Spilled food can cause serious burns. Keep appliance and cord away from children. **DO NOT** let cord hang over edge of tables or counters or touch hot surfaces.

- 45** When removable cooking pot is empty, **DO NOT** heat it for more than 10 minutes, as doing so may damage the cooking surface.
- 46** The cooking pot, Cook & Crisp Basket, and reversible rack become extremely hot during the cooking process. Avoid hot steam and air while removing the cooking pot and Cook & Crisp Basket from the appliance, and **ALWAYS** place them on a heat resistant surface after removing. **DO NOT** touch accessories during or immediately after cooking.
- 47** Removable cooking pot can be extremely heavy when full of ingredients. Care should be taken when lifting pot from cooker base.
- 48** Cleaning and user maintenance shall not be done by children unless they are older than 8 and supervised.
- 49** Let the appliance cool for approximately 30 minutes before handling, cleaning, or storing.
- 50** To disconnect, turn any control to "off", then unplug from socket when not in use and before cleaning. Allow to cool before cleaning, disassembly, putting in or taking off parts and for storage.
- 51** **DO NOT** clean with metal scouring pads. Pieces can break off the pad and touch electrical parts, creating a risk of electric shock.
- 52** Please refer to the Cleaning & Maintenance section for regular maintenance of the appliance.



Indicates to read and review instructions to understand operation and use of product.



Indicates the presence of a hazard that can cause personal injury, death or substantial property damage if the warning included with this symbol is ignored.



Take care to avoid contact with hot surface. Always use hand protection to avoid burns.



For indoor and household use only.

## SAVE THESE INSTRUCTIONS

# PARTS & ACCESSORIES

## PARTS

- A** Reversible Rack
- B** Cook & Crisp™ Basket
- C** Detachable Diffuser
- D** Removable 6L Cooking Pot
- E** Crisping Lid
- F** Heat Shield
- G** Control Panel
- H** Cooker Base
- I** Pressure Lid
- J** Pressure Release Valve
- K** Float Valve
- L** Silicone Ring
- M** Anti-Clog Cap
- N** Air Socket Vent
- O** Condensation Collector

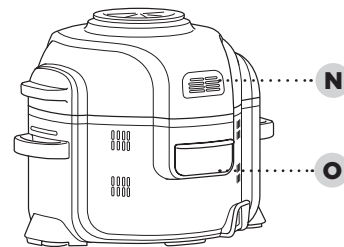
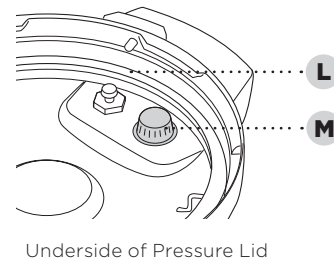
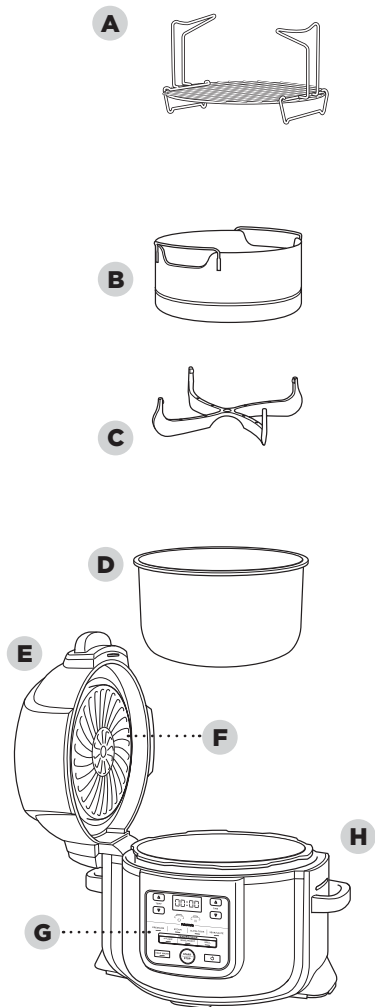

## ACCESSORIES (SOLD SEPARATELY)

- P** Cook & Crisp™ Layered Insert
- Q** Multi-Purpose Pan
- R** Roasting Rack Insert
- S** Dehydrating Rack
- T** Loaf Pan
- U** Crisper Pan

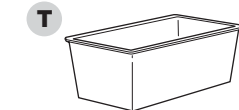
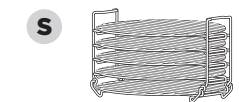
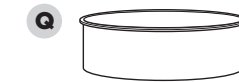
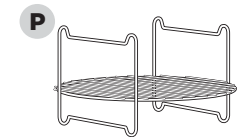

## USING THE CONTROL PANEL

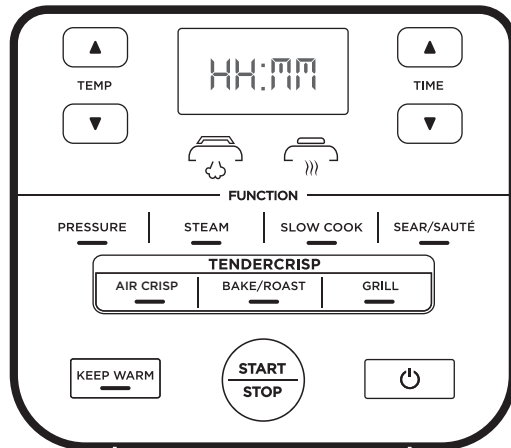

**NOTE:** Control panel may differ per model.

### FUNCTION BUTTONS

**PRESSURE:** Use to cook food quickly while maintaining tenderness.

**STEAM:** Use to gently cook delicate foods at a high temperature.

**SLOW COOK:** Cook your food at a lower temperature for longer periods of time.

**SEAR/SAUTÉ:** To use the unit for browning meats, sautéing vegetables, simmering sauces and more.

**AIR CRISP:** To use the unit as an air crisper to give foods crispiness and crunch with little to no oil.

**BAKE/ROAST:** To use the unit as an oven for tender meats, baked treats and more.

**GRILL:** Use to caramelize and brown your food.

### OPERATING BUTTONS

**TEMP arrows:** Use the up and down TEMP arrows to adjust the cook temperature and/or pressure level.

**TIME arrows:** Use the up and down TIME arrows to adjust the cook time.

**NOTE:** While cooking, to adjust temp or time, use the up and down arrows. The unit will then resume at those settings.

**START/STOP button:** After selecting your cooking temperature (or pressure) and cooking time. Press the START/STOP button to begin the cooking process. This can be stopped by pressing the button which the unit is in operation.

**KEEP WARM button:** After pressure cooking, steaming, or slow cooking, the unit will automatically switch to Keep Warm mode and start counting up. Keep Warm will stay on for 12 hours, or you may press KEEP WARM to turn it off. Keep Warm mode is not intended to warm food from a cold state but to keep it warm at a food-safe temperature.

⏻ The Power button turns off the unit and stops all cooking.

**STANDBY mode:** After 10 minutes with no interaction with the control panel, the unit will enter standby mode.

## BEFORE FIRST USE

- 1 Remove and discard any packaging material, promotional labels, and tape from the unit.
- 2 Remove all accessories from the packaging and read this manual carefully. Please pay particular attention to operational instructions, warnings, and important safeguards to avoid any injury or property damage.
- 3 Wash the pressure lid, Silicone ring, removable cooking pot, Cook & Crisp™ Basket, reversible rack and condensation collector in hot, soapy water, then rinse and dry thoroughly.
- 4 **NEVER** clean the cooker base in the dishwasher. Inspect the pressure lid to ensure there is no debris blocking the valves.
- 5 The Silicone ring is reversible and can be inserted in either direction. Insert the Silicone ring around the outer edge of the lid. Ensure it is fully inserted and lies flat under the Silicone ring rack.

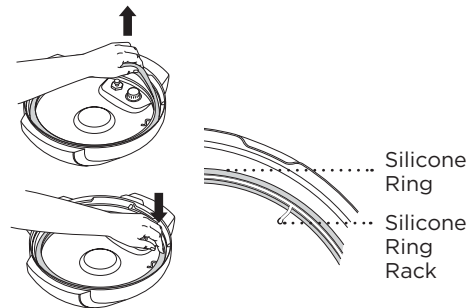

### INSTALLING THE CONDENSATION COLLECTOR

To install the condensation collector, slide it into the slot on the cooker base. Slide it out to remove it for hand-washing after each use.

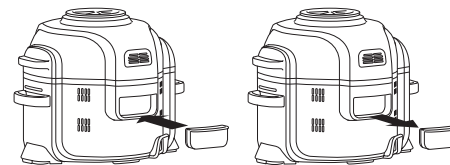

### REMOVING & REINSTALLING THE ANTI-CLOG CAP

Make sure your anti-clog cap is in the correct position before using the pressure lid. The anti-clog cap protects the inner valve of the pressure lid from clogging and protects users from potential food splashes. It should be **cleaned after every use** with a cleaning brush. To remove it, squeeze and pull upward. To reinstall, position it in place and press down.



**NOTE:** Prior to each use, make sure the Silicone ring is well seated in the Silicone ring rack and the anti-clog cap is mounted properly on the pressure release valve.



# USING YOUR NINJA® FOODI® TENDERCRISP® MULTI-COOKER

## SWAP THE TOP

The two lids allow you to seamlessly transition between all your favourite cooking methods. Use the pressure lid to tenderise, then use the crisping lid to crisp up your food.

## USING THE CRISPING LID

The crisping lid is attached to the unit and can be opened at any time to check on your food during the cooking process. When the lid is opened, the timer will pause, and the heating element will turn off. When the lid is closed, cooking will begin again and the timer will resume counting down.

## USING THE COOKING FUNCTIONS WITH THE CRISPING LID

To turn on the unit, plug the power cord into a socket, then press the Power button.

### Air Crisp

- 1 Press the AIR CRISP button. The default temperature setting will display. Use the up and down TEMP arrows to choose a temperature between 150°C and 200°C.

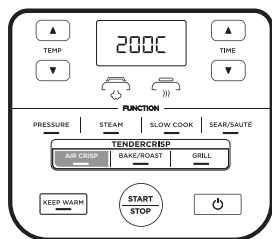

- 2 Use the up and down TIME arrows to set the cook time in minute increments up to 1 hour.

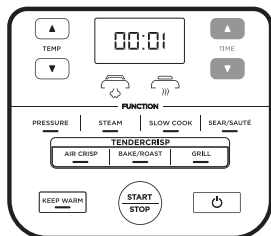

- 3 With the pot installed, place either the Cook & Crisp™ Basket or reversible rack in the pot. Basket must have the diffuser attached.

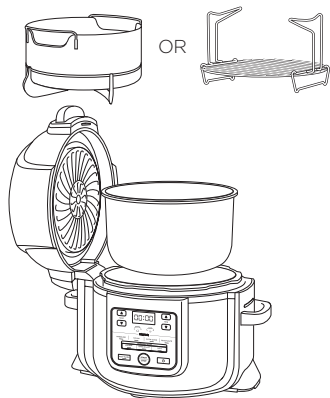

**NOTE:** It is recommended to let the unit preheat for 5 minutes before adding ingredients. When preheating, before step 4, close the lid, and press the START/STOP to begin.

- 4 Add ingredients to the Cook & Crisp™ Basket or reversible rack. Close the lid and press the START/STOP button to begin cooking.

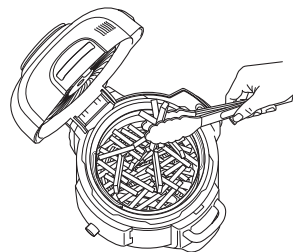

- 5 During cooking, you can open the lid and lift out the basket to shake or toss ingredients for even browning, if needed. When done, lower basket back into pot and close lid. Cooking will automatically resume after lid is closed.

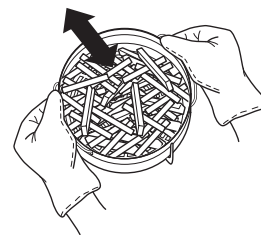

**NOTE:** If you press the STOP during Air Crisp Mode, the unit will wait 10 seconds before entering Standby mode.

- 6 When cooking is complete, the unit will beep.

## Bake/Roast

- 1 Press the BAKE/ROAST button. The default temperature setting will display. Use the up and down TEMP arrows to choose a temperature between 150°C and 200°C.

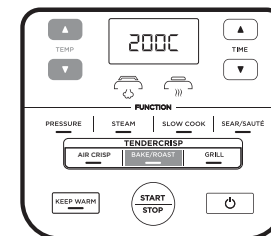

- 2 Use the up and down TIME arrows to set the cook time in minute increments up to 1 hour, 5-minute increments from 1 hour to 4 hours.

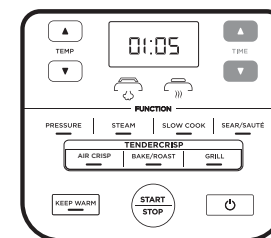

**NOTE:** If running for 1 hour or less, the clock will count down by minutes and seconds. If running for more than 1 hour, the clock will count down by minutes only.

**NOTE:** It is recommended to let the unit preheat for 5 minutes before adding ingredients. If preheating, before step 3, close the lid, and press the START/STOP button to begin.

- 3 Add ingredients, along with any accessories called for in your recipe, to the pot. Close the lid and press the START/STOP button to begin cooking.
- 4 When cooking is complete, the unit will beep.

# USING YOUR NINJA® FOODI® TENDERCRISP® MULTI-COOKER - CONT.

## Grill

- 1 Press the GRILL button.

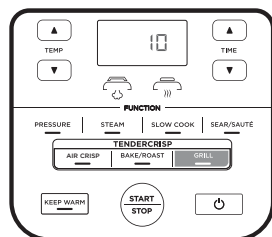

**NOTE:** There is no temperature adjustment available or necessary when using the Grill function.

- 2 Use the up and down TIME arrows to set the cook time in minute increments up to 30 minutes.

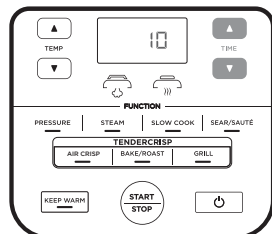

- 3 Place the reversible rack in the pot in the upper grill position or follow directions per recipe.

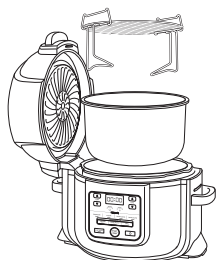

- 4 Place ingredients on the rack, then close the lid.

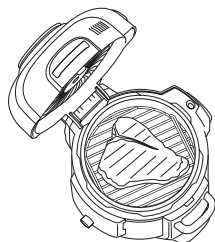

- 5 Press the START/STOP button to begin cooking.

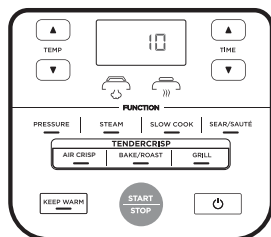

- 6 When cooking is complete, the unit will beep.

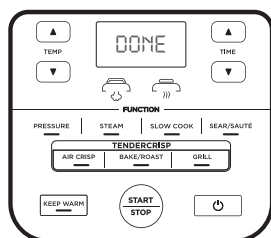

## PRESSURE TEST

### FAMILIARISING YOURSELF WITH PRESSURE COOKING

In order to familiarise yourself with the Pressure Cook function and start cooking, it is highly recommended for first-time users to do an initial run with water only.

- 1 Place the pot in the cooker base and add 700ml room-temperature water to the pot.

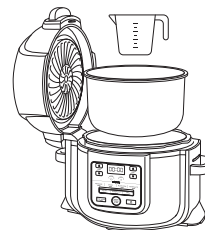

- 2 Assemble the pressure lid by aligning the arrow on the front of the lid with the arrow on the front of the cooker base. Then turn the lid clockwise until it locks into place.

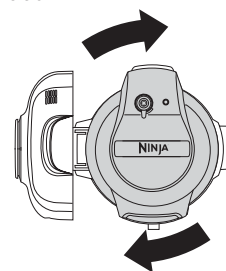

- 3 Make sure the pressure release valve on the lid is in the SEAL position.



- 4 Turn the unit on. Press the PRESSURE button, the unit will default to high (HI) pressure. Set the time to 2 minutes. Press the START/STOP button to begin.

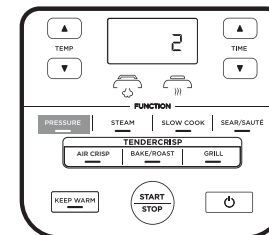

- 5 Your Ninja® Foodi® Multi-Cooker will begin to build pressure, indicated by the rotating lights. The unit will begin counting down when it is fully pressurised.

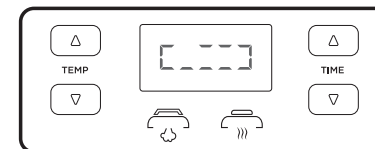

- 6 When the countdown is finished, the Ninja® Foodi® Multi-Cooker will beep, automatically switch to the Keep Warm mode, and begin counting up.

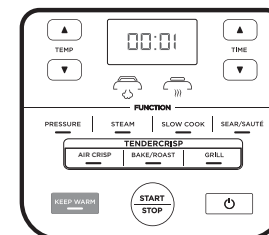

- 7 Turn the pressure release valve to the VENT position to quick release the pressurised steam. A quick burst of steam will spurt out of the pressure release valve. When steam is completely released, the unit will be ready to open.



**NOTE:** To maintain the quick release pressure, the valve will lock in to place in the VENT position.



# USING YOUR NINJA® FOODI® TENDERCRISP® MULTI-COOKER - CONT.

## NATURAL PRESSURE RELEASE VS. QUICK PRESSURE RELEASE

**Natural Pressure Release:** When pressure cooking is complete, steam will naturally release from the unit as it cools down. This can take up to 20 minutes or more, depending on the amount of liquid and food in the pot. During this time, the unit will switch to Keep Warm mode. Press the KEEP WARM button if you would like to turn Keep Warm mode off. When natural pressure release is complete, the float valve will drop down.

**Quick Pressure Release:** Use **ONLY** if your recipe calls for it. When pressure cooking is complete and the KEEP WARM light is on, turn the pressure release valve to the VENT position to instantly release pressure through the valve.

Even after releasing pressure naturally or using the pressure release valve, some steam will remain in the unit and will escape when the lid is opened. Lift and tilt it away from you, making sure no condensation drips into the cooker base.

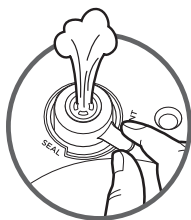

**NOTE:** At any time during the natural release process, you can switch to quick release by turning the pressure release valve to the VENT position.

**WARNING:** Caution HOT Steam emitted.

## PRESSURISING

As pressure builds in the unit, the control panel will display rotating lights. Pressurising time varies, depending on the amount of ingredients and liquid in the pot. As the unit pressurises, the lid will lock as a safety measure, and it will not unlock until pressure is released. Once the unit has reached full pressure, the lid pressure icon light will glow steadily. The pressure cooking cycle will begin and the timer will start counting down.

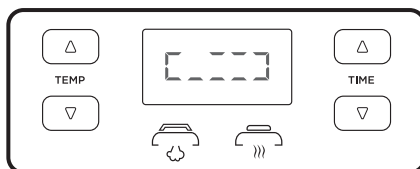

## INSTALLING & REMOVING THE PRESSURE LID

Place the pressure lid on top of the unit with the on the lid and the on the base lined up evenly. Turn the lid clockwise until it locks in place.

To unlock the pressure lid, turn it counterclockwise. Lift the lid at an angle to prevent splatter. Do not lift the lid straight up.

**NOTE:** The pressure lid will not unlock until the unit is completely depressurised.

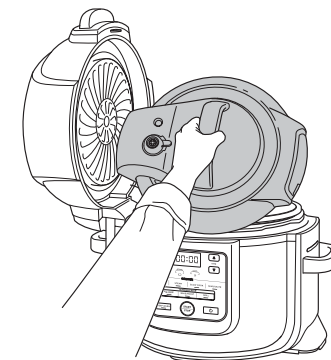
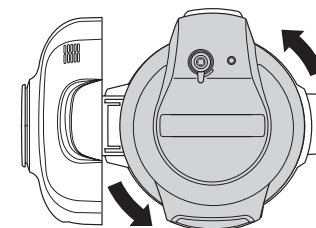
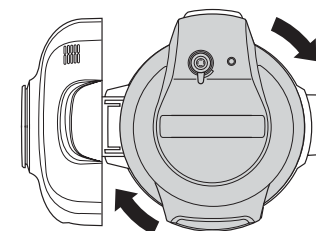
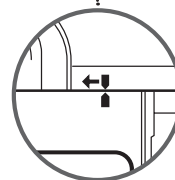
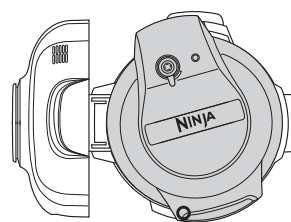
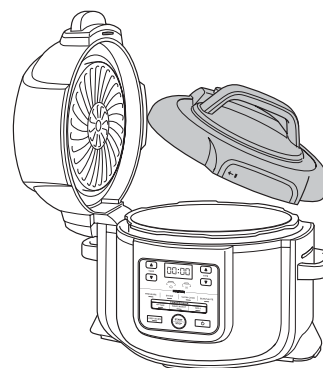

**WARNING:** Serious burns can result from the steam inside. **ALWAYS** lift and tilt the lid towards you when removing.

# USING YOUR NINJA® FOODI® TENDERCRISP® MULTI-COOKER - CONT.

## USING THE COOKING FUNCTIONS WITH THE PRESSURE LID

To turn on the unit, plug the power cord into a socket, then press the Power button.

### Pressure Cook

- 1 Place ingredients and at least 200ml of liquid in the pot, including an accessory if your recipe calls for it. **DO NOT** exceed the line marked PRESSURE MAX when pressure cooking.

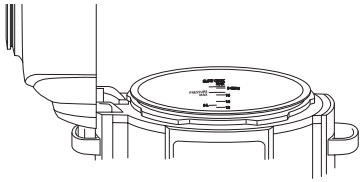

**NOTE:** When cooking rice, beans, or other ingredients that expand, **DO NOT** fill the pot more than halfway.

- 2 Follow the steps on page 16 to install the pressure lid. Turn the pressure release valve to the SEAL position.



- 3 Press the PRESSURE button. The default pressure level will display. Use the up and down TEMP arrows to select either HIGH or LOW.

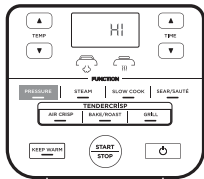

**NOTE:** If running for 1 hour or less, the clock will count down by minutes and seconds. If running for more than 1 hour, the clock will count down by minutes only.

- 4 Use the up and down TIME arrows to set the cook time in minute increments up to 1 hour, and in 5-minute increments from 1 hour to 4 hours.

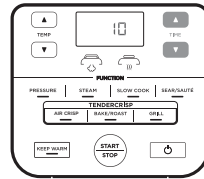

- 5 Press the START/STOP button. The display will show rotating lights during this time. When the unit reaches the proper temperature, the time you set will begin counting down.

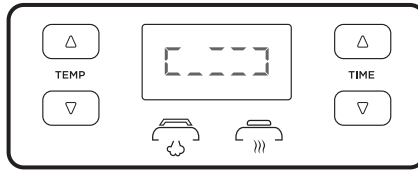

- 6 When cooking is complete, the unit will beep, automatically switch to Keep Warm mode, and start counting up from 00:00.

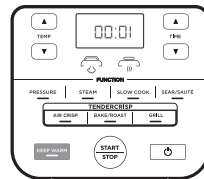

**NOTE:** After Pressure Cooking is complete, you may press the KEEP WARM button to turn the Keep Warm mode off.

- 7 Let the unit naturally release pressure or, if the recipe instructs, turn the pressure release valve to the VENT position, quickly releasing steam through the valve.



## Steam

- 1 Add 240ml of liquid (or amount of liquid the recipe specifies) to the pot, then place the reversible rack or Cook & Crisp™ Basket with ingredients in the pot.

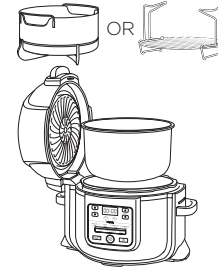

- 2 Follow the steps above to install the pressure lid on page 16. Turn the pressure release valve to the VENT position.



- 3 Press the STEAM button. Use the up and down TIME arrows to set the cook time in minute increments up to 30 minutes.

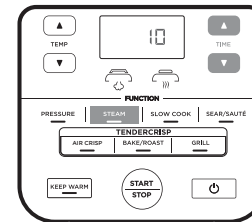

**NOTE:** There is no temperature adjustment available or necessary when using the Steam function.

- 4 Press the START/STOP button.
- 5 The unit will automatically preheat to bring the steaming liquid to a boil. The display will show rotating lights during this time. When the unit reaches the proper temperature, the time you set will begin counting down.

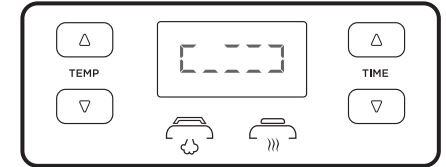

- 6 When cook time is complete, the unit will beep and automatically switch to Keep Warm mode. If the float valve pops up, wait for it to drop and then you can open the lid.

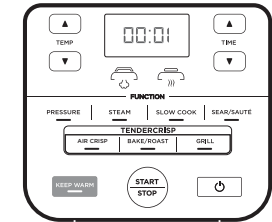

**NOTE:** After Steam cooking is complete, you may press the KEEP WARM button to turn the Keep Warm mode off.

## USING YOUR NINJA® FOODI® TENDERCRISP® MULTI-COOKER - CONT.

### Slow Cook

- 1 Add ingredients to the pot. **DO NOT** exceed the line marked MAX when slow cooking.
- 2 Follow the steps above to install pressure lid. Turn the pressure release valve to the VENT position.



- 3 Press the SLOW COOK button. The default temperature setting will display. Use the up and down TEMP arrows to select either Slow Cook HIGH or LOW.

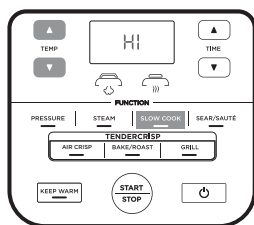

- 4 Use the up and down TIME arrows to set the cook time in 15-minute increments up to 12 hours.

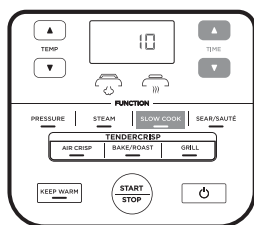

- 5 Press the START/STOP button to begin cooking.

**NOTE:** The Slow Cook HIGH time setting may be adjusted anywhere between 4 and 12 hours; the Slow Cook LOW time setting may be adjusted anywhere between 6 and 12 hours.

- 6 When cook time is complete, the unit will beep and automatically switch to Keep Warm mode.

### Sear/Sauté

- 1 Insert the pot.

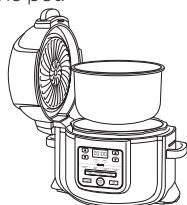

- 2 Press the SEAR/SAUTÉ button. The default temperature setting will display. Use the up and down TEMP arrows to select one of the setting options (low, medium-low, medium, medium-high, or high).

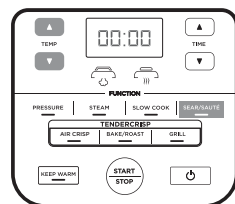

**NOTE:** There is no time adjustment available or necessary when using the Sear/Sauté function.

- 3 Press the START/STOP button to begin cooking.
- 4 To turn off the Sear/Sauté function, press the START/STOP button. To switch to a different cooking function, press the corresponding function button.

**NOTE:** You can use this function with either the crisping lid in the open position or the pressure lid with the pressure release valve in the VENT position.

**NOTE: ALWAYS** use nonstick utensils in the cooking pot. **DO NOT** use metal utensils, as they will scratch the nonstick coating on the pot.

## CLEANING & MAINTENANCE

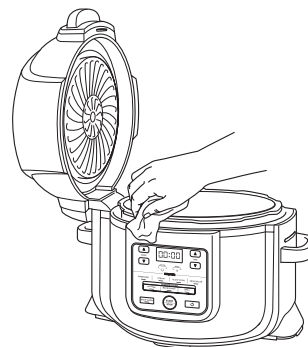

### Cleaning: Dishwasher & Hand-Washing

The unit should be cleaned thoroughly after every use.

- 1 Unplug the unit from the socket before cleaning.
- 2 **NEVER** put the cooker base in the dishwasher, or immerse it in water or any other liquid.
- 3 To clean the cooker base and the control panel, wipe with a clean damp cloth.
- 4 The pressure lid, cooking pot, Silicone ring, reversible rack, Cook & Crisp™ Basket and detachable diffuser can be washed in the dishwasher.
- 5 The pressure release valve and anti-clog cap, can be washed with water and dish soap. **DO NOT** take apart the pressure release valve or float valve assembly.
- 6 To clean the crisping lid, wipe it down with a wet cloth or paper towel after the heat shield cools.
- 7 If food residue is stuck on the cooking pot, reversible rack, or Cook & Crisp™ Basket, fill the pot with water and allow to soak before cleaning. **DO NOT** use scouring pads. If scrubbing is necessary, use a non-abrasive cleanser or liquid dish soap with a nylon pad or brush.
- 8 Air-dry all parts after each use, or use a soft dry towel.

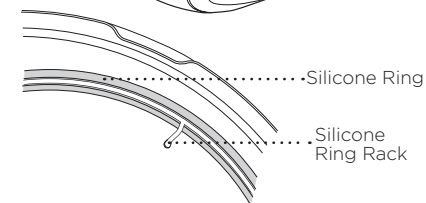
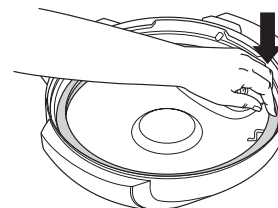
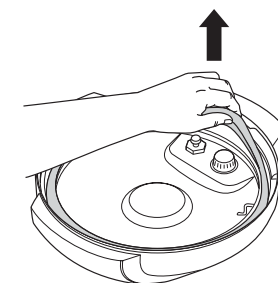

### Removing & Reinstalling the Silicone Ring

To remove the Silicone ring, pull it outward, section by section, from the Silicone ring rack. The ring can be installed with either side facing up. To reinstall, press it down into the rack section by section.

After use, remove any food debris from the Silicone ring and anti-clog cap.

**Keep the Silicone ring clean to avoid odour.** Washing it in warm, soapy water or in the dishwasher can remove odour. However, it is normal for it to absorb the smell of certain acidic foods. It is recommended to have more than one Silicone ring on hand. You can purchase additional Silicone Rings on [ninjakitchen.co.uk](http://ninjakitchen.co.uk).

**NEVER** pull out the Silicone ring with excessive force, as that may deform it and the rack and affect the pressure-sealing function. A Silicone ring with cracks, cuts, or other damage should be replaced immediately.

## ACCESSORIES FOR PURCHASE

We offer a suite of accessories custom made for your Ninja® Foodi® Tendercrisp® Multi-Cooker. Visit [ninjakitchen.co.uk](http://ninjakitchen.co.uk) to expand your capabilities and take your cooking to the next level.

### Cooking Pot

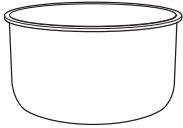

An extra pot so you can keep the Foodi fun going when your other pot is already full of delicious food.

### Silicone Muffin Mould

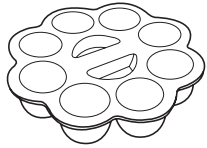

Bake your favourite mini muffins, cupcakes or egg bites in this flexible mould.

### Glass Lid



See into the pot during multiple cooking functions, then use to transport or store easily.

### Multi-Purpose Pan



- Create casseroles, dips and sweet and savoury pies or bake a fluffy, moist cake with a golden top for dessert.
- Dimensions: D22cm x H6cm

### Roasting Rack Insert

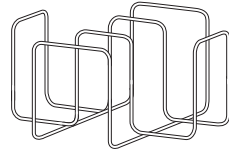

- Use this rack in the Cook & Crisp™ Basket to crisp up shells on Taco Tuesday, roast a rack of ribs on BBQ Sunday, or evenly toast garlic bread on pasta night.

### Crisper Pan

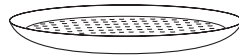

- Crisp and reheat pizzas quesadillas and vegetables.
- Dimensions: D23cm x H2cm

### Loaf Pan

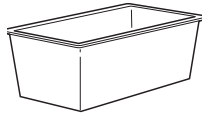

- Our specially designed pan is the perfectly sized baking accessory for bread mixes like banana and courgette.
- Dimensions: L21cm x W11cm x H9cm approx

### Extra Pack of Silicone Rings



- 2-pack Silicone ring set helps keep flavours separate - use one when cooking savoury foods and the other cooking sweet foods.

## TROUBLESHOOTING GUIDE

### Why is my unit taking so long to come to pressure? How long does it take to come to pressure?

- Cooking times may vary based on the selected temperature, current temperature of the cooking pot, and temperature or quantity of the ingredients.
- Check to make sure your Silicone ring is fully seated and flush against the lid. If installed correctly, you should be able to tug lightly on the ring to rotate it.
- Check that the pressure lid is fully locked, and the pressure release valve is in the SEAL position when pressure cooking.

### Why is the time counting down so slowly?

- You may have set hours rather than minutes. When setting time, the display will show HH:MM and the time will increase/decrease in minute increments.

### How can I tell when the unit is pressurising?

- The rotating lights will display on the screen to indicate the unit is building pressure.

### Lights are rotating on the display screen when using the Pressure or Steam function.

- This indicates the unit is building pressure or preheating when using STEAM or PRESSURE. When the unit has finished building pressure, your set cook time will begin counting down.

### There is a lot of steam coming from my unit when using the Steam function.

- It's normal for steam to release through the pressure release valve during cooking. Leave the pressure release valve in the VENT position for Steam, Slow Cook, and Sear/Sauté.

### Why can't I take the pressure lid off?

- As a safety feature, the pressure lid will not unlock until the unit is completely depressurised. Turn the pressure release valve to the VENT position to quick release the pressurised steam. A quick burst of steam will spurt out of the pressure release valve. When the steam is completely released, the unit will be ready to open. Turn the pressure lid anticlockwise, then lift it up and away from you.

### Is the pressure release valve supposed to be loose?

- Yes. The pressure release valve's loose fit is intentional; it enables a quick and easy transition between SEAL and VENT and helps regulate pressure by releasing small amounts of steam during cooking to ensure great results. Please make sure it is turned as far as possible toward the SEAL position when pressure cooking and as far as possible toward the VENT position when quick releasing.

### The unit is hissing and not reaching pressure.

- Make sure the pressure release valve is turned to the SEAL position. If you've done this and still hear a loud hissing noise, it may indicate your Silicone seal is not fully in place. Press START/STOP to stop cooking, VENT as necessary, and remove the pressure lid. Press down on the Silicone ring, ensuring it is fully inserted and lies flat under the ring rack. Once fully installed, you should be able to tug lightly on the ring to rotate it.

### The unit is counting up rather than down.

- The cooking cycle is complete and the unit is in Keep Warm mode.

### How long does the unit take to depressurise?

- Quick release is about 2 minutes or less. Natural release can take up to 20 minutes or more, depending on the type of food and/or the amount of liquid and food in the pot.

## TROUBLESHOOTING GUIDE

---

### “POT” error message appears on display screen.

- Cooking pot is not inside the cooker base. Cooking pot is required for all functions.

### “LID” error message appears on display screen and lid icon flashes.

- The incorrect lid is installed for your desired cooking function. Place the pressure lid on the unit if you want to use the Pressure, Slow Cook, Steam, Sear/Sauté, or Keep Warm functions and in the close position.

### “SHUT” error message appears on display screen.

- The crisping lid is open and needs to be closed for the selected function to start.

### “VENT” error message appears on display screen.

- When set to Slow Cook or Sear/Sauté, and the unit senses pressure building up, this message indicates the pressure release valve is in the SEAL position.
- Turn the pressure release valve to the VENT position and leave it there for the remainder of the cooking function.
- If you do not turn the pressure release valve to the VENT position within 5 minutes, the program will cancel and the unit will shut off.

### “WATR” error message appears on display screen when using the Steam function.

- The water level is too low. Add more water to the unit for the function to continue.

### “WATR” error message appears on display screen when using the Pressure function.

- Add more liquid to the cooking pot before restarting the pressure cook cycle.
- Make sure the pressure release valve is in the SEAL position.
- Make sure the Silicone ring is installed correctly.

### “HOT” error message appears on display screen.

- This indicates the unit has overheated. Let the unit cool down.
- Once unit has cooled down, ensure there is no food caked on the bottom of the pot and there is enough liquid in the pot for the recipe you are preparing.

### “ERR” message appears.

- The unit is not functioning properly. Please contact Customer Service at 0800 862 0453.

## HELPFUL TIPS

---

- 1 For consistent browning, make sure ingredients are arranged in an even layer on the bottom of the cooking pot with no overlapping. If ingredients are overlapping, make sure to shake half way through the set cook time.
- 2 For smaller ingredients that could fall through the reversible rack, we recommend first wrapping them in a parchment paper or foil pouch.
- 3 When switching from pressure cooking to using the crisping lid it is recommended to empty the pot of any remaining liquid for best crisping results.
- 4 Press and hold down the up or down Time arrows to move faster through Time display.
- 5 Use the Keep Warm mode to keep food at a warm, food-safe temperature after cooking. To prevent food from drying out, we recommend keeping the lid closed and using this function just before serving. To reheat food, use the Air Crisping function.
- 6 To have your unit build pressure quicker, set it to SEAR/SAUTÉ HIGH. Once ready to pressure cook, press the PRESSURE button and continue as you normally would.

## REPLACEMENT PARTS

---

To order additional parts and accessories, visit [ninjakitchen.co.uk](http://ninjakitchen.co.uk) or contact Customer Service at 0800 862 0453.

## PRODUCT REGISTRATION

---

Please visit [registeryourninja.com](http://registeryourninja.com) or call 0800 862 0453 to register your new Ninja® product within 28 days of purchase. You will be asked to provide the store name, date of purchase, and model number along with your name and address.

The registration will enable us to contact you in the unlikely event of a product safety notification.

**NOTE:** Save these instructions. Keep for future reference.





VISIT US ONLINE AT:

ninjakitchen.co.uk

Or follow us on any of our social media pages:



@ninjakitchenuk



**NOTE:** Save these instructions. Keep for future reference.



This marking indicates this product should not be disposed of with other household waste. To prevent possible harm to the environment or human health from uncontrolled waste disposal, recycle it responsibly to promote the sustainable reuse of material sources. To return your used device, please use the return and collection systems or contact the retailer where this product was purchased. They can take this product for environmentally safe recycling.

**SharkNinja Europe Limited**  
**3150 Century Way,**  
**Thorpe Park,**  
**Leeds,**  
**LS15 8ZB, UK**  
**0800 862 0453**  
**ninjakitchen.co.uk**

**SharkNinja Germany GmbH, c/o Regus Management GmbH**  
**Excellent Business Center 10**  
**+11/Stock Westhafenplatz 1 60327 Frankfurt am Main, Germany**

Illustrations may differ from actual product. We are constantly striving to improve our products, therefore the specifications contained herein are subject to change without notice.

FOODI, NINJA and TENDERCRISP are registered trademarks of SharkNinja Operating LLC.  
COOK & CRISP is a trademark of SharkNinja Operating LLC

© 2021 SharkNinja Operating LLC

OP300UKSeries\_IB\_REV\_211006\_MV1  
PRINTED IN CHINA

