

NINJA®

Foodi®

Flip Mini Oven

SP101UK

INSTRUCTIONS



THANK YOU

for purchasing the Ninja® Foodi® Mini Oven



REGISTER YOUR PURCHASE

 ninjakitchen.co.uk/registerguarantee

 Scan QR code using mobile device

RECORD THIS INFORMATION

Model Number: _____

Serial Number: _____

Date of Purchase: _____
(Keep receipt)

Store of Purchase: _____

TECHNICAL SPECIFICATIONS

Voltage: 220-240V~, 50-60Hz

Watts: 2000W-2400W

TIP: You can find the model and serial numbers on the QR code label located on the base of the unit.

PRODUCT REGISTRATION:

Please visit ninjakitchen.co.uk or call 0800 862 0453 to register your new Ninja® product within 28 days of purchase. You will be asked to provide the store name, date of purchase, and model number along with your name and address.

The registration will enable us to contact you in the unlikely event of a product safety notification. By registering, you acknowledge you have read and understood the instructions for use and warnings set forth in the accompanying instructions.

CONTENTS

Important Safeguards	2
Parts	4
Accessory Placement	5
Before First Use	5
Using the Control Panel	6
Functions	7
Control Panel Display & Operating Buttons	7
Using Your Foodi® Mini Oven	8
Using the Cooking Functions	8
Air Fry	8
Roast	9
Grill	9
Bake	10
Toast	10
Bagel	11
Dehydrate	11
Keep Warm	11
Cleaning, Maintenance & Storage	12
Everyday Cleaning	12
Deep Cleaning	12
Flip-Up-And-Away Storage	13
Power Cord Management	14
Accessories for Purchase	14
Troubleshooting	15
FAQ	15

IMPORTANT SAFEGUARDS

HOUSEHOLD USE ONLY • READ ALL INSTRUCTIONS BEFORE USE

When using electrical appliances, basic safety precautions should always be followed, including the following:

⚠ WARNING

- 1 This appliance can be used by persons with reduced physical, sensory or mental capabilities or lack of experience and knowledge if they have been given supervision or instruction concerning use of the appliance in a safe way and understand the hazards involved.
- 2 To eliminate a choking hazard for young children, discard all packaging materials immediately upon unpacking.
- 3 Take inventory of all contents to ensure you have all parts needed to properly and safely operate your oven.
- 4 **DO NOT** use an extension cord. A short power-supply cord is used to reduce the risk of children grabbing the cord or becoming entangled and to reduce the risk of people tripping over a longer cord.
- 5 **NEVER** use socket below worktop.
- 6 Keep the appliance and its cord out of reach of children. **Do not allow the appliance to be used by children.** Close supervision is necessary when used near children.
- 7 **DO NOT** let cord hang over edges of tables or counters or touch hot surfaces, including stoves and other heating ovens.
- 8 **NEVER** leave the oven unattended while in use.
- 9 **DO NOT** cover crumb tray or any part of the oven with metal foil. This will cause the oven to overheat or cause a fire.
- 10 **NEVER** place aluminum foil on top of the oven tray or wire rack. This traps grease and can cause a fire.
- 11 To protect against electrical shock **DO NOT** immerse cord, plugs or main unit housing in water or other liquid.
- 12 **DO NOT** use the oven with damage to the power cord or plug. Regularly inspect the oven and power cord. If the oven malfunctions or has been damaged in any way, immediately stop use and call Customer Service.
- 13 **DO NOT** cover the air intake vents or air socket vents while unit is operating. Doing so will prevent even cooking and may damage the unit or cause it to overheat.
- 14 **DO NOT** insert anything in the ventilation slots and do not obstruct them.
- 15 **DO NOT** place items on top of surface while unit is operating except for authorised recommended Ninja accessories.
- 16 Before placing any accessories into the oven ensure they are clean and dry.
- 17 Intended for worktop use only. **DO NOT** place the oven near the edge of a worktop. Ensure the surface is level, clean and dry.
- 18 This oven is for household use only. **DO NOT** use this oven for anything other than its intended use. Misuse may cause injury.
- 19 **DO NOT** store any materials, other than supplied accessories, in this oven when not in use.
- 20 **DO NOT** use outdoors. **DO NOT** use in moving vehicles or boats.
- 21 **DO NOT** use accessory and attachments not recommended or sold by SharkNinja.
- 22 When using this oven, provide adequate space above and on all sides for air circulation.
- 23 A fire may occur if the oven is covered or touching flammable material, including curtains, draperies, walls, or the like when in operation. **DO NOT** place anything on the oven during operation.

- 24 This oven has a tempered glass door and is more resistant to breakage. Avoid scratching door surface or nicking edges.
- 25 **DO NOT** use the oven without the wire rack installed, except when using Air Fry Basket.
- 26 **DO NOT** spray any type of aerosol spray or flavoring inside the oven while cooking.
- 27 Use caution when inserting and removing anything from the oven, especially when hot.
- 28 Socket voltages can vary, affecting the performance of your product. To prevent possible illness, use a thermometer to check that your food is cooked to the temperatures recommended.
- 29 Prevent food contact with heating elements. Excessive food loads may cause personal injury or property damage or affect the safe use of the oven.
- 30 **DO NOT** place any of the following materials in the oven: paper, cardboard, plastic, roasting bags and the like.
- 31 Extreme caution should be exercised when using containers constructed of any materials other than metal or glass.
- 32 **DO NOT** touch hot surfaces. Oven surfaces are hot during and after operation. To prevent burns or personal injury, **ALWAYS** use protective hot pads or insulated oven mitts and use available handles and knobs.
- 33 Spilled food can cause serious burns. Extreme caution must be used when the oven contains hot food. Improper use may result in personal injury.
- 34 Please refer to the Cleaning & Maintenance section for regular maintenance of the oven.
- 35 Cleaning and user maintenance shall not be made by children.
- 36 Press the power button to turn oven off and allow to cool completely before cleaning, moving and flipping for storage.
- 37 Unplug from socket when not in use. To unplug, grasp the plug by the body and pull from the socket. Never unplug by grasping and pulling the flexible cord.
- 38 **DO NOT** clean with metal scouring pads. Pieces can break off the pad and touch electrical parts, causing a risk of electrical shock.
- 39 **DO NOT** use the oven as a source of heat or for drying.
- 40 **NEVER** connect this appliance to an external timer switch or separate remote control system.



Indicates to read and review instructions to understand operation and use of product.



Indicates the presence of a hazard that can cause personal injury, death or substantial property damage if the warning included with this symbol is ignored.



Take care to avoid contact with hot surface. Always use hand protection to avoid burns.



For indoor and household use only.

SAVE THESE INSTRUCTIONS

PARTS

- A** Main Unit
(attached power cord not shown)

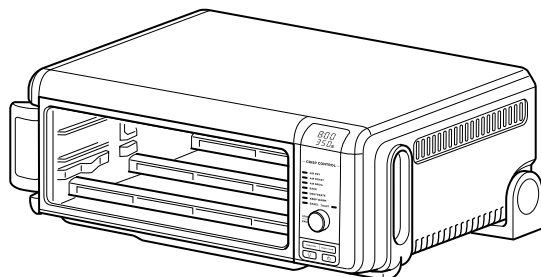

- B** Air Fry Basket
(use in the top rail position)



- C** Oven Tray
(always layer on top of the wire rack)



- D** Wire Rack
(keep in the bottom rail position)

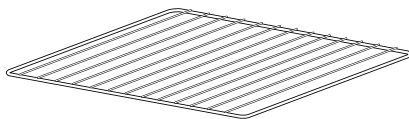

- E** Removable Crumb Tray
(always place below the bottom heating element)

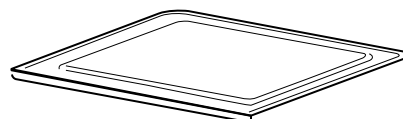

ACCESSORY PLACEMENT

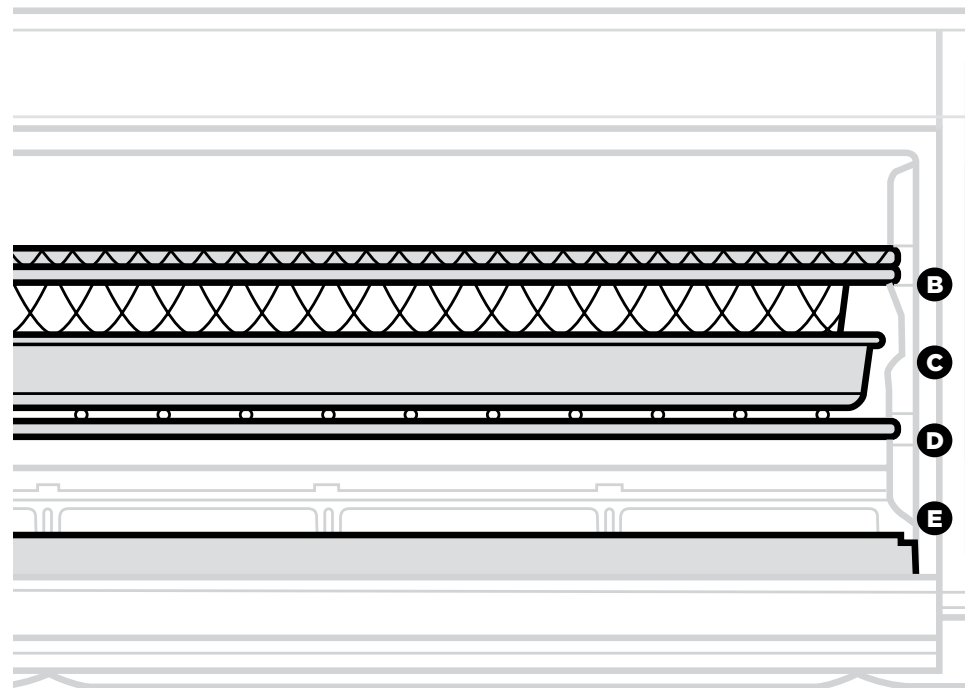

BEFORE FIRST USE

- 1 Remove and discard any packaging material, promotional labels and tape from the unit.
- 2 Remove all accessories from the package and read this manual carefully. Please pay particular attention to operational instructions, warnings and important safeguards to avoid any injury or property damage.
- 3 Wash the air fry basket, oven tray, wire rack and removable crumb tray in warm, soapy water, then rinse and dry thoroughly. **NEVER** clean the main unit in the dishwasher.
- 4 We recommend placing all accessories inside the oven and running it on Air Fry at 200°C for 20 minutes without adding food. Make sure the area is well ventilated. This removes any packaging residue and odour traces that may be present. This is completely safe and not detrimental to the performance of the oven.

NOTE: For longevity, we recommend hand-washing the accessories.

To order additional parts and accessories, visit ninjakitchen.co.uk or contact Customer Service at **0800 862 0453**.

USING THE CONTROL PANEL

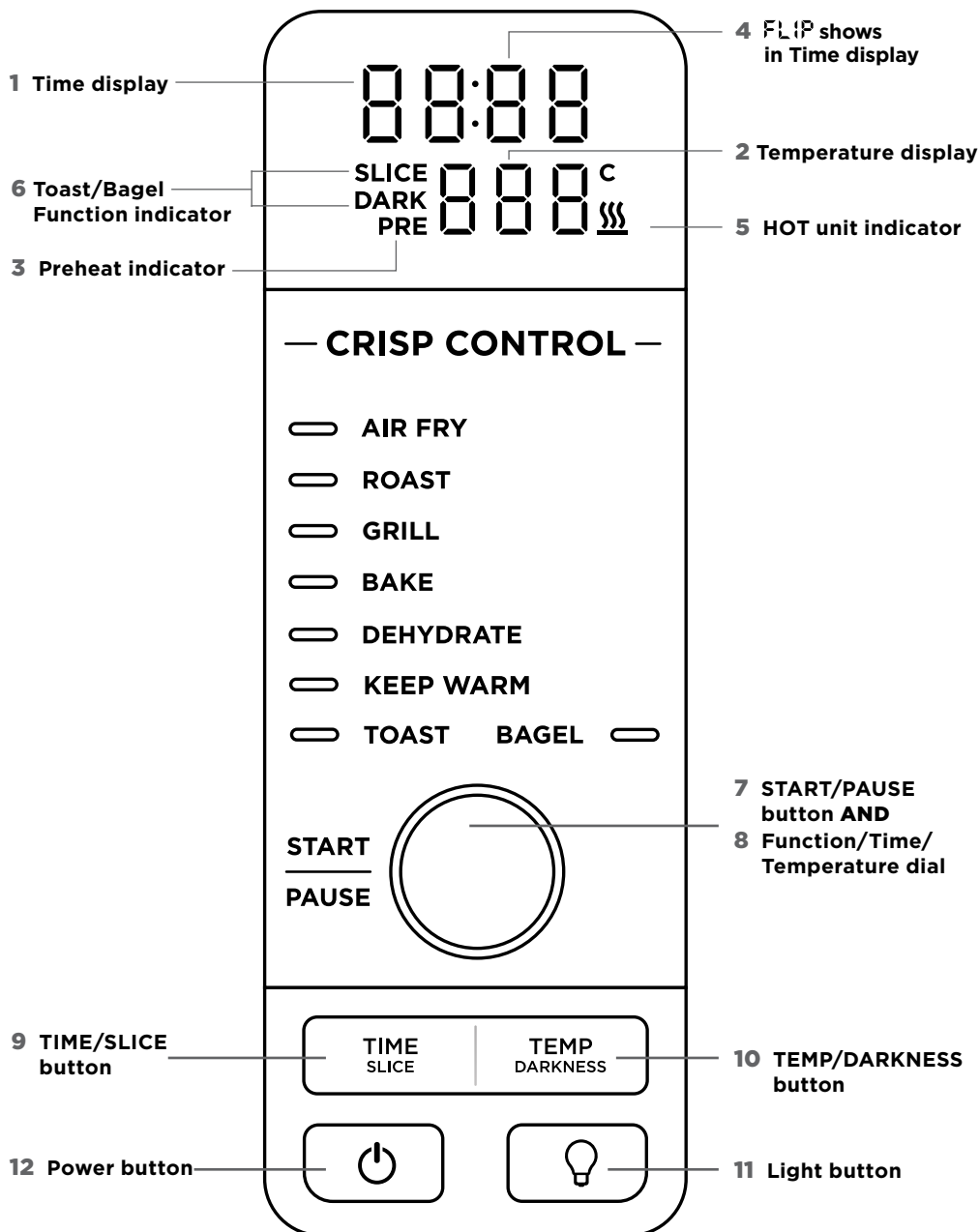

FUNCTIONS

AIR FRY: Make foods that would traditionally be fried—such as chicken wings, French fries and chicken nuggets—with little to no added oil.

ROAST: Achieve a crispy outside and perfectly cooked inside for full-sized oven tray meals, chunkier proteins and roasted vegetables.

GRILL: Grills meat and fish and evenly browns the tops of casseroles.

BAKE: Evenly bakes everything from your favourite cookies to homemade pizzas.

TOAST: Evenly toasts up to 6 slices of bread to your perfect level of darkness.

BAGEL: Perfectly toast up to 6 bagel halves when they're placed cut-side up on the wire rack.

DEHYDRATE: Dehydrates meats, fruits and vegetables for healthy snacks.

KEEP WARM: Keeps food warm up to 2 hours.

CONTROL PANEL DISPLAY & OPERATING BUTTONS

1 Time display: Shows the cook time. The time will count down when cooking is in progress.

2 Temperature display: Shows the cook temperature.

NOTE: Time and temperature will always return to the cook time and temperature that was set the last time the oven was in use.

3 PRE flashes when the unit is preheating.

4 FLIP will appear on the time display when the unit is cool enough to flip up for storage or cleaning.

5 illuminates when the unit is hot and will turn off when the oven is cool enough to be flipped up for storage or cleaning.

6 SLICE and **DARK** will illuminate when using the Toast or Bagel function.

7 START/PAUSE button: Press to start or pause cooking.

8 Function/Time/Temperature dial: Turn to select a cooking function or adjust time and temperature (or number of slices and darkness level when using the Toast and Bagel functions).

NOTE: Press and hold the START/PAUSE button for 3 seconds to return to the function selection.

9 TIME/SLICE button: To select a cook time, press the TIME button, then use the dial to adjust the time. When using the Toast or Bagel function, this button will adjust the number of slices instead of the time.

10 TEMP/DARKNESS button: To adjust temperature, press the TEMP button and use the dial to adjust the temperature. When using the Toast or Bagel function, this button will adjust the darkness level instead of the temperature.

NOTE: The cook time and temperature may be adjusted at any time during the cooking cycle.

11 (Light) button: Press to turn the oven's interior light on and off.

NOTE: The light will automatically turn on when there are 30 seconds of cook time remaining.

12 (Power) button: Press to turn the unit on and off.

USING YOUR FOODI® MINI OVEN

USING THE COOKING FUNCTIONS

To turn on the unit, plug the power cord into the wall, flip oven down into cooking position, and press the  button.

NOTE: The unit preheats quickly, so we recommend prepping all ingredients before turning on the oven.

Air Fry

- 1 To select the function, turn the dial until AIR FRY illuminates. The default time and temperature settings will display.
- 2 Press the TIME/SLICE button and use the dial to select your time up to 1 hour. To set the time, press the TIME/SLICE button again.
- 3 Then press the TEMP/DARKNESS button and use the dial to select a temperature between 120°C-205°C. To set the temperature, press the TEMP/DARKNESS button again.
- 4 Press START/PAUSE to begin preheating.
- 5 Place ingredients in the air fry basket. If ingredients are fatty, oily or marinated, place the basket on the oven tray.



Use air fry basket for dry ingredients.

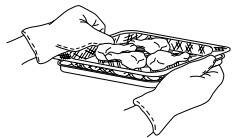

Use air fry basket with oven tray underneath for fatty, oily or marinated ingredients.

- 6 Slide the basket into the upper rails of the oven. If also using the oven tray, slide both into the oven at the same time, with the basket in the upper rails and the pan on the wire rack beneath the basket. Close oven door.

NOTE: The timer will start counting down as soon as the unit has preheated. If ingredients are not ready to go into the oven, simply turn the dial to add more time.

- 7 For more even browning and crispiness, toss ingredients or turn the basket 180° halfway through cooking cycle.

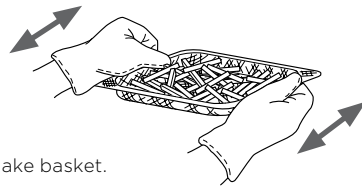

Shake basket.

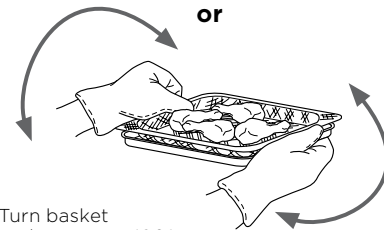

Turn basket and oven tray 180°.

- 8 When cook time is complete, the unit will beep.

Roast

- 1 To select the function, turn the dial until ROAST illuminates. The default time and temperature settings will display.
- 2 Press the TIME/SLICE button and use the dial to select your time up to 2 hours. To set the time, press TIME/SLICE button again.

NOTE: If cooking for less than 1 hour the clock will count down by minutes and seconds. If cooking for more than 1 hour, the clock will count down by hours and minutes.

- 3 Press the TEMP/DARKNESS button and use the dial to select a temperature between 120°C-230°C. To set the temperature, press the TEMP/DARKNESS button again.
- 4 Press START/PAUSE to begin preheating.

NOTE: Food cooks faster when using the ROAST function than when using the BAKE function, so for traditional oven recipes, lower the cook time 30% and lower the temperature 10°C.

- 5 Place ingredients on the oven tray. When the unit beeps to signify it has preheated, immediately place the oven tray on the wire rack. Close oven door.

NOTE: The timer will start counting down as soon as the unit has preheated. If ingredients are not ready to go into the oven, simply turn the dial to add more time.

- 6 During cooking, you can open the oven door to check on or flip ingredients.

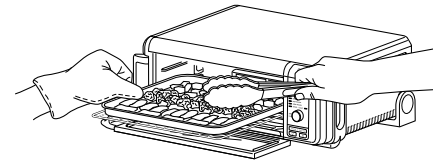

- 7 When cook time is complete, the unit will beep.

Grill

- 1 To select the function, turn the dial until GRILL illuminates. The default time and temperature settings will display.
- 2 Press the TIME/SLICE button and use the dial to select your time up to 30 minutes. To set the time, press the TIME/SLICE button again.
- 3 Press the TEMP/DARKNESS button and use the dial to select either HI or LO. To set the temperature, press the TEMP/DARKNESS button again.
- 4 Place ingredients on the oven tray. Place the sheet pan on the wire rack and close the oven door, press START/PAUSE to start cooking.

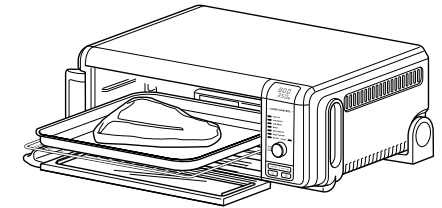

- 5 During cooking, you can open the oven door to check on or flip ingredients.

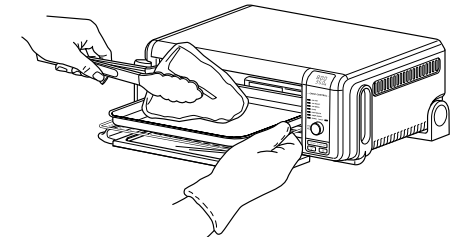

- 6 When cook time is complete, the unit will beep.

USING YOUR FOODI® MINI OVEN - CONT.

Bake

- 1 To select the function, turn the dial until BAKE illuminates. The default time and temperature settings will display.
- 2 Press the TIME/SLICE button and use the dial to select your time up to 2 hours. To set the time, press the TIME/SLICE button again.

NOTE: If cooking for less than 1 hour the clock will count down by minutes and seconds. If cooking for more than 1 hour, the clock will count down by hours and minutes.

- 3 Press the TEMP/DARKNESS button and use the dial to select a temperature between 120°C-230°C. To set the temperature, press the TEMP/DARKNESS button again.
- 4 Press START/PAUSE to begin preheating.
- 5 Place ingredients on the oven tray. When the unit beeps to signify it has preheated, immediately place the oven tray on the wire rack. Close oven door.

NOTE: The timer will start counting down as soon as the unit has preheated. If ingredients are not ready to go into the oven, simply turn the dial to add more time.

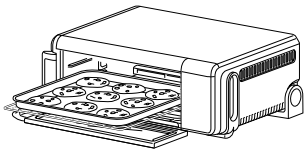

- 6 During cooking, you can open the oven door to check on or flip ingredients.

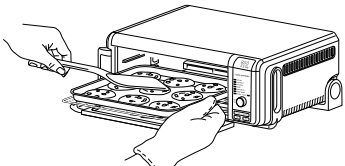

- 7 When cook time is complete, the unit will beep.

NOTE: For best results with baked goods such as cookies, line the oven tray with baking parchment paper.

Toast

- 1 To select the function, turn the dial until TOAST illuminates. The default amount of slices and darkness will be displayed.
- 2 Press the TIME/SLICE button and use the dial to select the number of bread slices. You may toast up to 9 slices at once. To set the number of slices, press the TIME/SLICE button again.
- 3 Press the TEMP/DARKNESS button and use the dial to select a darkness level. To set the darkness level, press the TEMP/DARKNESS button again.

NOTE: There is no temperature adjustment available for the TOAST function, and the unit does not preheat in Toast mode. It is very important to select the exact number of slices to avoid over- or under-toasting.

- 4 Place bread slices on the wire rack. Close oven door and press START/PAUSE to begin cooking.

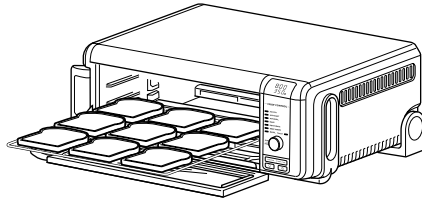

- 5 You do not need to flip the slices during cooking. When cook time is complete, the unit will beep.

Bagel

- 1 To select the function, turn the dial until BAGEL illuminates. The default number of slices and darkness level will display.
- 2 Press the TIME/SLICE button and use the dial to select the number of slices. You may toast up to 6 bagel slices at once. To set the number of slices, press the TIME/SLICE button again.
- 3 Press the TEMP/DARKNESS button and use the dial to select a darkness level. To set the darkness level, press the TEMP/DARKNESS button again.

NOTE: There is no temperature adjustment available for the BAGEL function, and the unit does not preheat in BAGEL mode. It is very important to select the exact number of slices to avoid over- or under-toasting.

- 4 Place bagel slices, cut-side up, on the wire rack. Close oven door and press START/PAUSE to begin cooking.

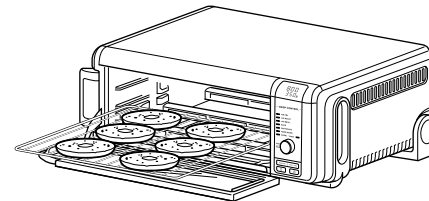

- 5 You do not need to flip the slices during cooking. When cook time is complete, the unit will beep.

Dehydrate

- 1 To select the function, turn the dial until DEHYDRATE illuminates. The default time and temperature settings will display.
- 2 Press the TIME/SLICE button and use the dial to select a time up to 12 hours. To set the time, press the TIME/SLICE button again.
- 3 Press the TEMP/DARKNESS button and use the dial to select a temperature between 40°C-90°C. To set the temperature, press the TEMP/DARKNESS button again.

- 4 Place ingredients in the air fry basket and place basket in oven. Close oven door and press START/PAUSE to begin cooking.

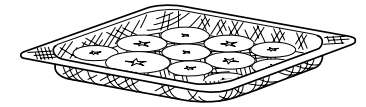

- 5 During cooking, you can open the oven door to check on or flip ingredients.
- 6 When cook time is complete, the unit will beep.

Keep Warm

NOTE: The KEEP WARM function is not included on all models.

- 1 To select the function, turn the dial until KEEP WARM illuminates. The default time setting will display.
- 2 Press the TIME/SLICE button and use the dial to select a time up to 2 hours. To set the time, press the TIME/SLICE button again.

NOTE: There is no temperature selection available for the KEEP WARM function.

- 3 Place food on the oven tray or in an oven-safe container and place the pan or container on the wire rack. Close oven door and press START/PAUSE to begin warming.

NOTE: The unit does not preheat in Keep Warm mode.

- 4 When warming time is complete, the unit will beep.

CLEANING, MAINTENANCE & STORAGE

EVERYDAY CLEANING

The unit should be cleaned thoroughly after every use.

- 1 Unplug the unit from the socket and allow it to cool down before cleaning.
- 2 Empty crumb tray by sliding it out of the oven when the oven is in the flipped-down position.

NOTE: Empty crumb tray frequently. Hand-wash when necessary.

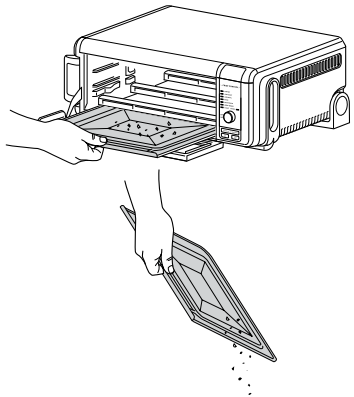
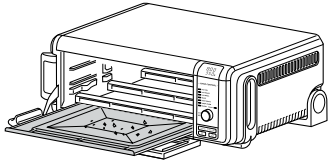

- 3 To clean any food splatter on the interior walls of the unit, wipe them with a soft, damp sponge.
- 4 To clean the exterior of the main unit and the control panel, wipe them clean with a damp cloth. A non-abrasive liquid cleanser or mild spray solution may be used. Apply the cleanser to the sponge, not the oven surface, before cleaning.

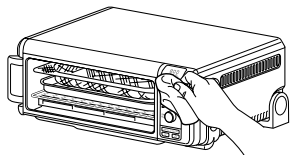

DEEP CLEANING

- 1 Unplug the unit from the socket and allow it to cool down before cleaning.
- 2 Remove all accessories from the unit, including the crumb tray and wash separately. Use a non-abrasive cleaning brush to more thoroughly wash the air fry basket.
- 3 Flip up the oven into the storage position.

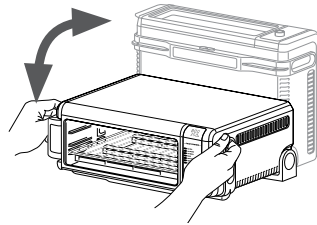

- 4 Press the push button to release the back door to access the oven's interior.

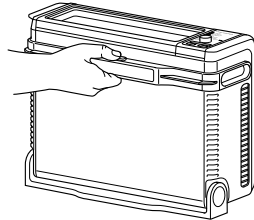

- 5 Use warm, soapy water and a soft cloth to wash the oven's interior. **DO NOT** use abrasive cleaners, scrubbing brushes or chemical cleaners, as they will damage the oven.

CAUTION: NEVER put the main unit in the dishwasher or immerse it in water or any other liquid.

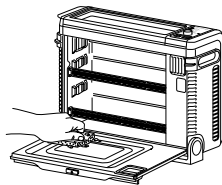

CLEANING, MAINTENANCE & STORAGE - CONT.

- 6 To prolong use of accessories, hand-wash with warm, soapy water.
- 7 Thoroughly dry all parts before placing them back in the oven.

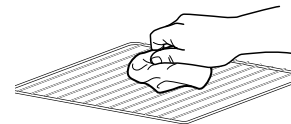
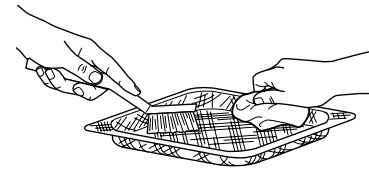

TIP: For stuck on food residue, leave accessories to soak in soapy water overnight.

FLIP-UP-AND-AWAY STORAGE

- 1 **DO NOT** flip oven up when  is illuminated. Wait for oven to cool down before handling. Hold handles on each side of the unit.

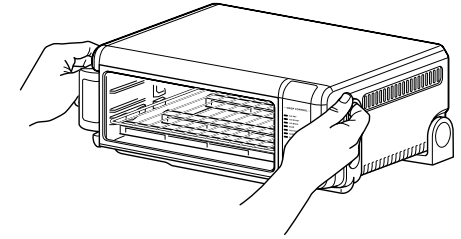

- 2 Lift and flip unit upward.

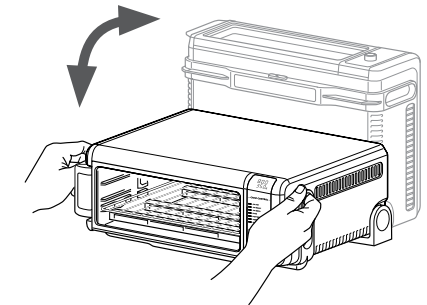

- 3 Leave the unit in the upright position when storing or for deep cleaning.

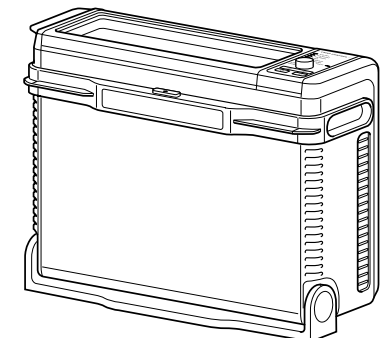

POWER CORD MANAGEMENT

Our cord-management system is designed so it will not interfere with the oven's flip-away functionality.

Option 1 Socket on the left

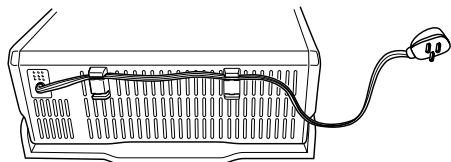

Option 2 Socket on the right

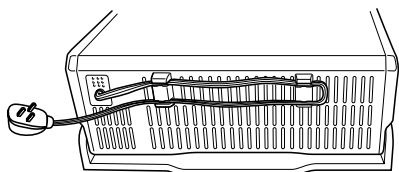

Option 3 Socket behind the oven

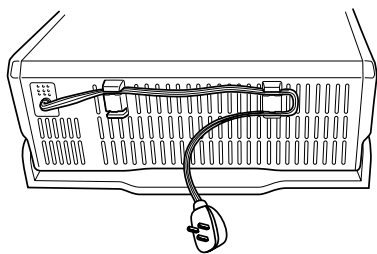

ACCESSORIES FOR PURCHASE

We offer a range of accessories custom made for your Ninja® Foodi® Mini Oven. Visit ninjakitchen.co.uk to expand your capabilities and take your cooking to the next level.

• Grilling Rack

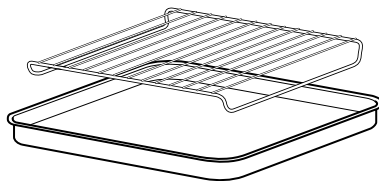

• Casserole Dish/Baking Pan (5cm deep)

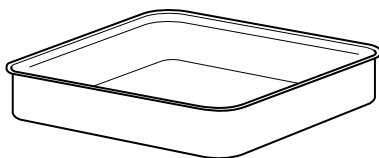

• Egg Bite/Muffin Tray

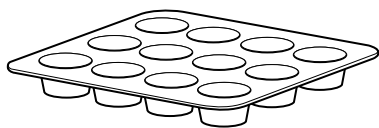

TROUBLESHOOTING

ERROR MESSAGES

“CALL CUSt SrVC” followed by “Er1” - “Er7”

Power off the unit and call Customer Service at **0800 862 0453**. So we may better assist you, please register your product online at ninjakitchen.co.uk/registerguarantee and have the product on hand when you call.

FAQ

Why won't the oven turn on?

- Oven needs to be in flipped-down position in order to power it on.
- Make sure the power cord is securely plugged into the socket.
- Insert the power cord into a different socket.
- Reset the circuit breaker if necessary.
- Press the power button.

Can I use the oven tray instead of the air fry basket with air fry function?

- Yes, but crispiness results may vary.

Do I need to adjust the cook times and temperatures of traditional oven recipes?

- When preparing traditional oven recipes using the Roast function, lower cook time by 30% and temperature by 10°C.

Can I restore the unit to its default settings?

- The oven will remember the last setting used for each function, even if you unplug it. To restore the oven's default settings for each function, press the TIME/SLICE and TEMP/DARKNESS buttons simultaneously for 5 seconds.

Why do the heating elements appear to be turning on and off?

- This is normal. The oven is designed to control temperature precisely for every function by adjusting the heating elements' power levels.

Why is steam coming out from the oven door?

- This is normal. The door is vented to release steam created by foods with a high moisture content.

Why is water dripping onto the counter from under the door?

- This is normal. The condensation created by foods with a high moisture content (such as frozen breads) may run down the inside of the door and drip onto the counter.

Why is there noise coming from the control panel?

- When the oven is hot, a fan turns on to cool down the control panel.

Can foil or baking paper be used?

- Aluminium foil should not be used. However, baking paper or greaseproof paper is recommended for when baking or for generally keeping the tray clean.

Are the accessories dishwasher safe?

- For longevity we recommend hand washing accessories. For stuck-on residue, leave to soak before cleaning.

VISIT US ONLINE AT:

ninjakitchen.co.uk

Or follow us on any of our social media pages:



NOTE: Save these instructions. Keep for future reference.



This marking indicates this product should not be disposed of with other household wastes throughout the EU. To prevent possible harm to the environment or human health from uncontrolled waste disposal, recycle it responsibly to promote the sustainable reuse of material sources. To return your used device, please use the return and collection systems or contact the retailer where this product was purchased. They can take this product for environmentally safe recycling.

SharkNinja Europe Limited
3150 Century Way,
Thorpe Park, Leeds, LS15 8ZB, UK

SharkNinja Germany GmbH, c/o Regus Management GmbH
Excellent Business Center 10
+11/Stock Westhafenplatz 1 60327 Frankfurt am Main, Germany

Illustrations may differ from actual product. We are constantly striving to improve our products, therefore the specifications contained herein are subject to change without notice.

FOODI and NINJA are registered trademarks of SharkNinja Operating LLC.

© 2021 SharkNinja Operating LLC

PRINTED IN CHINA

SP101UK_IB_MP_Mv1_210831

